

WINDING, MEASURING & WAREHOUSE TECHNOLOGY

Complete Catalogue



A company of the Corporate Group

 **HELUKABEL**[®]

 **kabelmat**[®]
easy winding. easy working.



EDITORIAL

Specific types and lengths of cable are often required at short notice. Kabelmat offers a wide product range that covers almost all requirements. The range of applications now extends far beyond the cable and wire industry. We always focus on how our customers use our products. If even modified modules from our standard range are not sufficient, we create custom-made system solutions. Today, more than ever, Kabelmat is in demand as a system partner and offers comprehensive solutions from a single source. Kabelmat offers a high safety standard that is incomparable with many other providers.

Kabelmat Wickeltechnik GmbH

More than **60 years of experience**

ABOUT US	6
Kabelmat Wickeltechnik	6
Production	8
Project planning & Engineering	9
Consulting & Sales	10
Service	11
MANUAL WINDING TECHNOLOGY	12
Coil and spool winder	14
• MESSROL 450	14
• MESSROL 670 / 1000	18
• MESSROL 500	24
• TISCHROL 450	30
• TISCHROL 1000	32
Coil and spool unwinder	35
• RINGFIX / SPULFIX	35
• KOMBITRAK 800	38
• RINGO 500	40
• TROMBOI 500 - 1400	41
Drum unwinder	41
• TROMBOI 7-10 / 9-14	42
• TROMBOI 2003	43
• TROMTRAK 1250	44
• TROMCAR 1000 / 1250	45
MACHINE WINDING TECHNOLOGY	46
Length cutting machine	48
• AUTOCUT 40	48
Coil and spool winder	50
• MOTROL 500	50
• MOTROL 800 EASY	52
• MOTROL 800	54
• MOTROL 1000	56
Semi-automatic coil winder	58
• RINGROL 600	58
• RINGROL 800	60
Fully automatic coil winder	62
• RINGROL 1200	62
Pintle winder for coils and drums	64
• UMROL 1000 AUF	64
• UMROL 1400 / 1600 / 2200 AUF	66
• PORTROL 1000 / 1400 AUF	69
Pintle unwinder for drums	71
• PORTROL 1000 / 1400 ABW	71
Drum and spool unwinder	73
• TROMPIN 800 / 1250	73

Coil and spool unwinder	74
• SPULFIX 480	74
Drum axle unwinder	76
• TROMTRAK 1600	76
• TROMROL 2500	77
Sinter machine	78
• SIGNOMAT	78
MACHINERY PLANTS AND LINES	80
• AUTOLOG	82
• PORTROL	86
LENGTH MEASURING TECHNOLOGY	90
Length measuring devices	92
• Conformity assessment	92
• MESSBOI 10	94
• MESSBOI 25	96
• MESSBOI 40 B LC / LC-MID	97
• MESSBOI 40 BAE	98
• MESSBOI 40 LC / LC-MID	100
• MESSBOI 80 LC / LC-MID	103
• MESSBOI 100 LC / LC-MID	104
• MESSBOI 100 LASER	105
WAREHOUSE TECHNOLOGY	106
Storage and unwindig system for coils, tubes and plastic pipes	108
• MATBOI	108
Storage and unwinding devices for spools	112
• SPULBOI	112
Drum rack and unwinding system	116
• LAGBOI 2200 / 3000	116
• LAGROL	118
• ABROL	123
Transport and loading tool	124
• TROMSTOP	124
• TROMPLAT 1000 / 2500	125
Spool storage and unwinding device	126
• SPULROLLY	126
Drum storage and unwinding device	127
• TROMBULLY	127
OUR PRODUCT RANGE	128
Get to know the complete Kabelmat product world	128
HELUKABEL® GmbH	130
A leading manufacturer and distributor of cables and wires	130

Kabelmat Wickeltechnik

Specialists for the storage and processing of winding materials

Kabelmat Wickeltechnik GmbH's history goes back to the sixties and the company has been one of the leaders for winding systems for the cable and wire industry and processing. Customers include manufacturers, retailers and processors of cables and wires as well as fitters, electrical installers, machine construction companies and many more.

The product portfolio includes almost **all devices and machines for storage, winding of cables, wires, steel cables, pipes, hoses and profiles**. The tasks completed worldwide by Kabelmat products include winding from and to drums, as well as from drums to coils.

We will be glad to answer your questions about:

- Storage
- Transport
- Unwinding
- Length Measurement
- Cutting
- Winding
- Bind and pack



Production

Focus on quality, safety and user-friendliness

We carry out almost all upstream production stages ourselves - all at our site in Glatten. This results in short chains of command and high flexibility. The basis of our products is a modular system. We can quickly assemble customer-specific devices from these device modules. We work together with renowned manufacturers

and market leaders in the selection of raw materials. Whether drive technology or pneumatic components - the use of high-quality raw materials is an integral part of our product policy. In the area of user-friendliness and safety technology Kabelmat also offers a standard that is incomparable with many other manufacturers.

- Production facility in Germany, location Glatten
- „Made in Germany“
- Use of components from renowned manufacturers
- Basic modular system

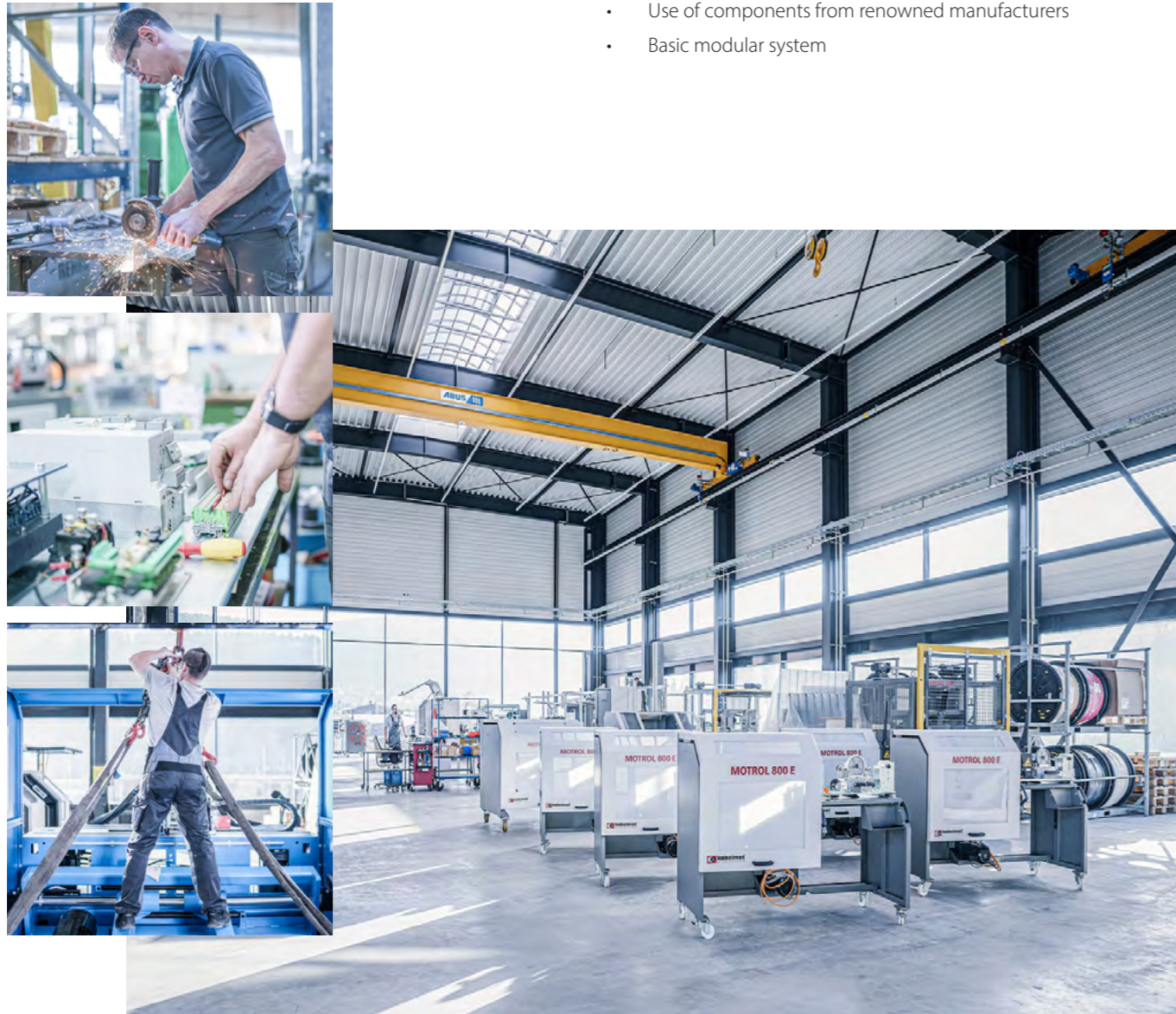

Project planning & Engineering

Your application is in the foreground - we offer the right solution

Our product portfolio is modular and can therefore be flexibly adapted to your application.

For certain tasks, even modified modules from our standard assortment are not sufficient. In these cases, we develop customised system solutions.

- Comprehensive know-how
- Broad product portfolio
- High safety standard
- High quality parts
- Realisation of demanding tasks
- Customer-specific solutions
- And much more



Consulting & Sales

Best advice

To find the right solution, our sales team will assist you in a professional manner. We are happy to advise you by telephone or on site. Find the contact person in your area on the Internet at www.kabelmat.com.

We will also be glad to show you our products in our showroom. You are cordially invited to visit our company. We look forward to your visit.



Always close to you

Trough the efficient sales network of our parent company, HELUKABEL® GmbH, we have more than 40 field staff

working nationwide and are represented by 55 sales locations and many agents on all continents of the world.

PART OF HELUKABEL GROUP

2200
Employees

60
Sales & Production Locations

796
Mio. € turnover
in 2021

37
Represented
in 37 countries

HELUKABEL

Service

We are there for you

Whether rapid assistance on site or time-saving support via telephone. - Our in-house customer service team is there for you. For us, this service is not just any old service, but is regarded as part of our partnership-based cooperation. Our products are synonymous with high quality and a long service life, and we attach great importance to the permanent, faultless operability of your machine.

Our in-house customer service team offers regular checks and maintenance to ensure maximum operational reliability and a long service life of the machines and systems, so that possible breakdowns can be detected and avoided in advance. Furthermore, the operating parameters of your machine can be continuously optimised.

Service at a glance:

- Training
- Commissioning
- Original spare parts
- Technical documentation
- Preventative maintenance
- Customer service
- Telephone support
- Repairs and modifications

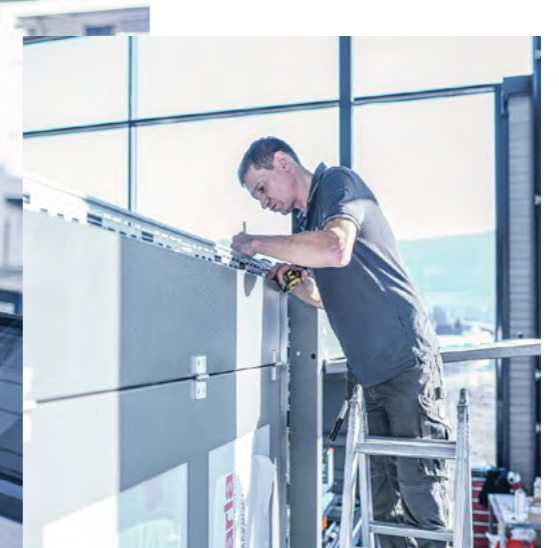
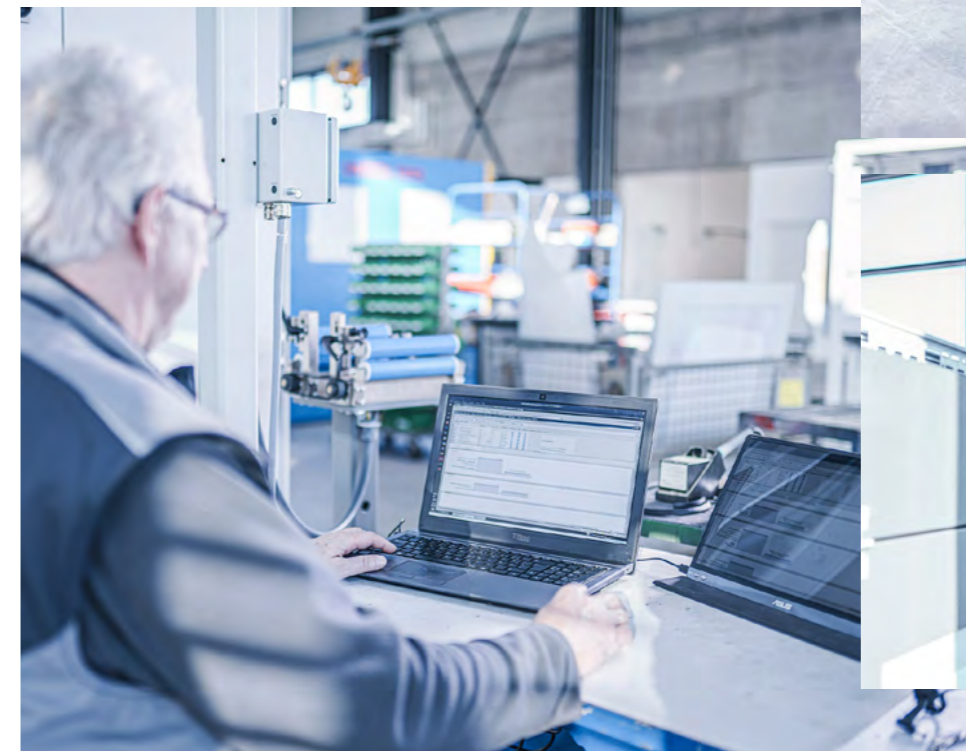

MANUAL WINDING TECHNOLOGY

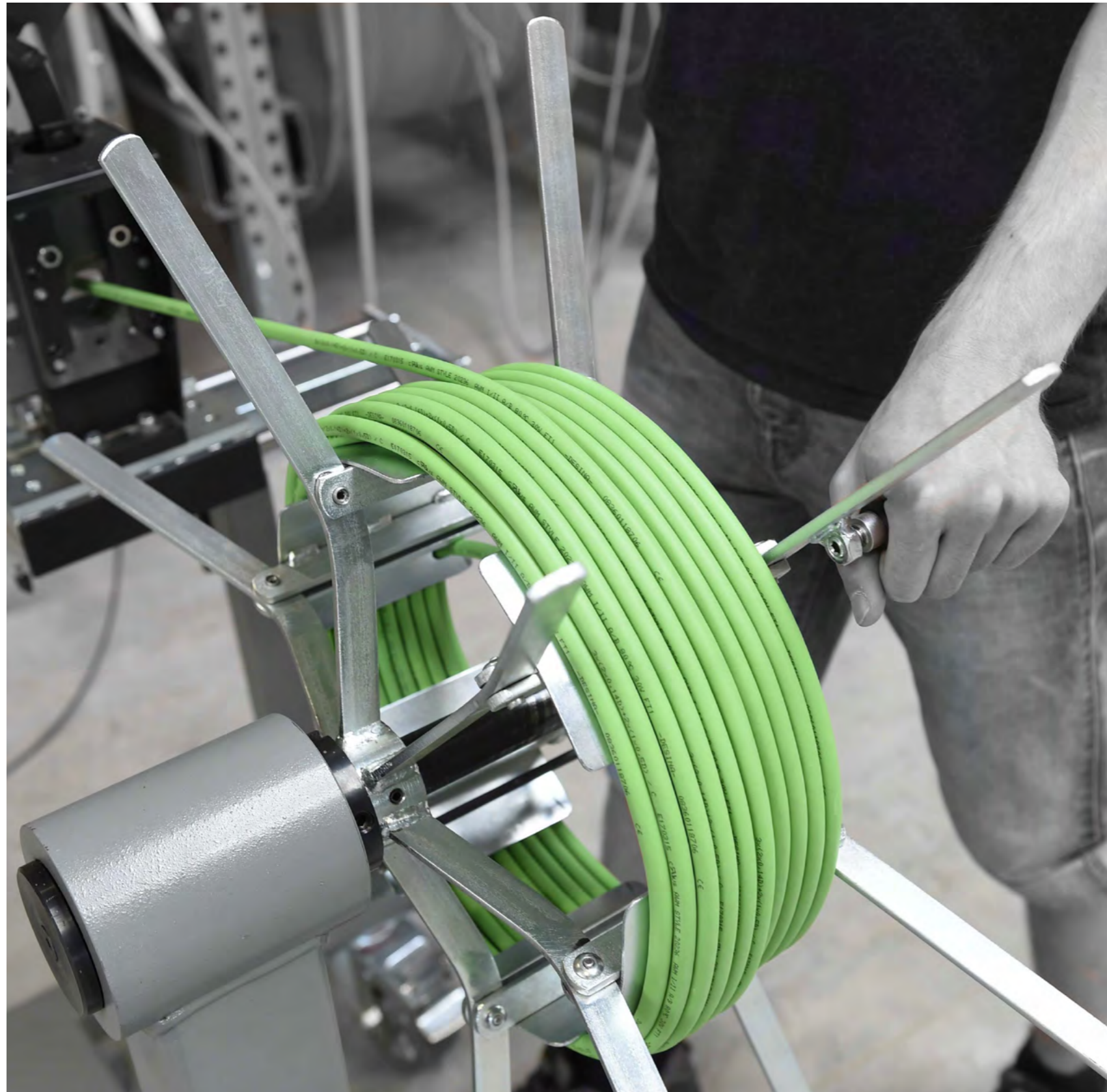

PRODUCTS

- MESSROL 450 14
- MESSROL 670 / 1000 18
- MESSROL 500 24
- TISCHROL 450 30
- TISCHROL 1000 32
- RINGFIX / SPULFIX 35
- KOMBITRAK 800 38
- RINGO 500 40
- TROMBOI 500 - 1400 41
- TROMBOI 7-10 / 9-14 42
- TROMBOI 2003 43
- TROMTRAK 1250 44
- TROMCAR 1000 / 1250 45

MESSROL 450

Coil and spool rewriter, manual

Rewind coils and spools while simultaneously measuring



Fig. 1: MESSROL 450 complete device with RAPID 450 SP, RINGFIX 480 and MESSBOI 10

MESSROL 450

- Coil and spool rewriter for small coils and spools

Functionality:

This manual coil and spool rewriter enables to wind winding material like cables, wires etc. from coils or spools into smaller coils or onto smaller spools while at the same time the material is measured exactly.

- Flexible modular system
- Easy winding while simultaneously measuring
- Adjustable break mechanism at the base frame avoid an uncontrolled material flow
- Easy assembly and removal of the coils and spools
- Continuous and central tension of the coils



Fig. 2: MESSROL 450 with spool winding axle, MESSBOI 25 with roller cage unit and inlet roller

MESSROL 450

Coil and spool rewriter, manual

Complete device

Complete device	MESSROL 450 complete device
Part No.	86001121
consisting of:	
Frame	85100436
Pillar mobile	85100437
RINGFIX 480	85101509
RAPID 450 SP	85100090
MESSBOI 10	85100471
Technical device	
L x W x H	approx. 1000 x 400 x 1200 mm
Colour	RAL 7005 mouse grey
Weight	approx. 48 kg

Frame

Technical data	MESSROL 450 base frame / desk frame
Part No.	85100436
Axle holder-Ø	Ø 20 mm
L x W x H	approx. 1000 x 400 x 350 mm
Colour	RAL 7005 mouse grey
Weight	approx. 14,5 kg

Pillars with rollers for base frame

Technical data	MESSROL 450 mobile
Part No.	85100437
Steering rollers (4 pcs. set)	brakeable
Colour	RAL 7005 mouse grey
Material	steel
Weight (Set)	12 kg
Length	approx. 750 mm
Scope: 4 pillars with brakeable steering rollers	

Inlet roller for unwinding from drums

Technical data	MESSROL 450 inlet roller
Part No.	85100438
Inlet roller	Ø 50 mm
Colour	RAL 7005 mouse grey
Weight	approx. 3,4 kg



Fig. 3: MESSROL 450 complete device

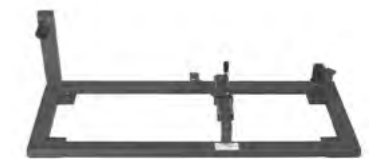

Fig. 4: MESSROL 450 base frame / desk frame



Fig. 5: MESSROL 450 pillar mobile



Fig. 6: MESSROL 450 inlet roller

Coiler head with hand crank

Technical data	RAPID 400 SP	RAPID 450 SP
Part No.	85100089	85100090
Coil-Ø	max. 400 mm	max. 450 mm
Winding width	max. 70 mm	max. 70 mm
Core-Ø	130 mm	250 mm
Axle holder-Ø	20 mm	20 mm
Load capacity	max. 15 kg	max. 15 kg
Colour	galvanised	galvanised
Material	steel	steel
Weight	approx. 4,0 kg	approx. 4,5 kg



Fig. 7: RAPID 400 SP

Spool winding axle with hand crank

Technical data	Spool winding axle
Part No.	86118100
Spool-Ø	max. 310 mm
Spool width	max. 220 mm
Spool bore	25 - 80 mm
Load capacity	max. 10 kg
Axle holder-Ø	20 mm
Axle	Ø 16 mm x 270 mm
Colour	RAL 7035 light grey



Fig. 8: Spool winding axle with hand crank

Coil unwinding plate

Technical data	RINGFIX 480
Part No.	85101509
Coil-Ø	max. 470 mm
Plate-Ø	480 mm
Height core bolts	250 mm
Core adjusting range	140 - 320 mm
Load capacity	max. 20 kg
Colour	zinc-plated
Weight	approx. 15 kg



Fig. 9: RINGFIX 480

Spool unwinding plate

Technical data	SPULFIX 480
Part No.	85101516
Spool-Ø	max. 470 mm
Spool width	max. 150 mm
Plate-Ø	480 mm
Core bolt dimensions	Ø 16 x 200 mm
Centering cone for bore	25 - 80 mm
Load capacity	max. 25 kg
Colour	zinc-plated
Weight	approx. 5,7 kg

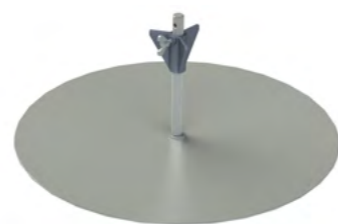

Fig. 10: SPULFIX 480

Length measuring device

Technical data	MESSBOI 10
Part No.	85100471
Measuring range	1 - 15 mm
L x W x H	approx. 160 x 110 x 85 mm
Display of counter	9999,99 m
Error limit	+ / -2 %
Measuring force	Spring pressure
Measuring wheel	Plastic
Housing	Polystyrene
Colour	black / white
Weight	approx. 0,5 kg

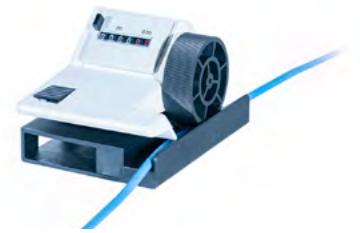

Fig.11: MESSBOI 10

Technical data	MESSBOI 25	MESSBOI 25 conformity assessed*
Part No.	85101000	86101000
Measuring range	2 - 25 mm	2 - 15 mm
L x W x H	approx. 120 x 160 x 350 mm	approx. 120 x 160 x 350 mm
Display of counter	9999,99 m	9999,99 m
Error limit	+/- 0,5 %	+/- 0,5 %
Measuring wheel	aluminum with vulcanized PUR coating	aluminum with vulcanized PUR coating
Housing	aluminum	aluminum
Weight	approx. 1,4 kg	approx. 1,4 kg
Colour	RAL 7005 mouse grey	RAL 7005 mouse grey

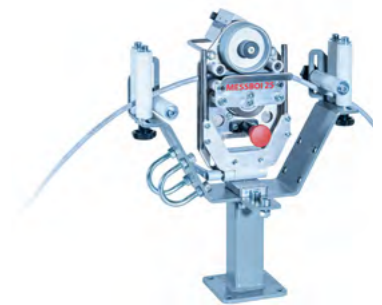

Fig. 12: MESSBOI 25 with roller cage unit

Technical data	Inlet and outlet roller cage for MESSBOI 25
Art.-Nr.	85101001
Roller cage unit for better guidance of the winding goods. Note: In combination with MESSROL 450 the inlet and outlet roller cage unit is necessary.	

*Conformity assessment of the length measuring device according module F1 with additional inlet and outlet roller cage is approved by German calibration authority. Valid for an unlimited period in the EEA. Conformity assessment has to be carried out in the manufacturing firm. Re-assessment after two years is not required, but maintenance by Kabelmat is recommended. **Only approved for useage in direct sales!**

Manual winding,
measuring and cutting



Fig. 1: MESSROL 670 with RAPID 600 SP and MESSBOI 25 with roller cage unit

MESSROL 670 / 1000

Manual coil and spool winder

Functionality:

This manual coil and spool winder enables to wind winding material like cables, wires etc. into coils or onto spools while length measuring and cut to length at the same time.

- Modular system
- Easy winding while length measuring at the same time
- Movable traversing slide for a smooth winding pattern
- Easy assembly and removal of the coils and spools
- Optional: cutting device
- Optimal combination / supplement with unwinder or drum rack

Modular system

Possible combination:



Fig. 2: MESSROL 1000 base frame



Fig. 3: RAPID 800 SL



Fig. 4: MESSBOI 40 BAE with inlet roller cage and MATIS 25 M



Fig. 5: MESSROL 1000 with RAPID 800 SL, MESSBOI 40 BAE, inlet roller cage and MATIS 25 M

Complete device

Complete device with measuring device

Complete device	MESSROL 670
Part No.	86100015
Components	consisting of:
Base frame mobile	Part No. 86180439
MESSBOI 25	Part No. 85101000
Inlet and outlet roller cage unit	Part No. 85101001
RAPID 600 SP	Part No. 85100091
Technical data	
L x W x H	approx. 880 x 680 x 1210 mm
Colour	RAL 7005 mouse grey
Weight	approx. 52 kg



Fig. 6: MESSROL 670 complete device

Complete device with measuring device / cutting unit

Complete device	MESSROL 1000
Part No.	85100015
Components	consisting of:
Base frame mobile	Part No. 85100439
MESSBOI 40 BAE	Part No. 85100003
Inlet roller cage	Part No. 85100189
MATIS 25	Part No. 85100163
RAPID 600 SP	Part No. 85100091
Technical data	
L x W x H	approx. 1250 x 710 x 910 mm
Colour	RAL 7005 mouse grey
Weight	approx. 80 kg



Fig. 7: MESSROL 1000 complete device

Complete device without measuring device / cutting unit

Complete device	MESSROL 1000 RM
Part No.	86180500
Components	consisting of:
Base frame mobile	Part No. 86180440
RAPID 850 ST	Part No. 85100466
Technical data	
L x W x H	approx. 1200 x 710 x 1135 mm
Colour	RAL 7005 mouse grey
Weight	approx. 67 kg



Fig. 8: MESSROL 1000 RM complete device

MESSROL 670 / 1000

Coil and spool winder, manual

Base frame

Technical data	MESSROL 1000	MESSROL 670
Part No.	85100439	86180439
Coil-Ø / Spool-Ø	max. 1000 mm	max. 670 mm
Axle holder-Ø	30 mm	30 mm
Traversing width	250 mm	250 mm
L x W x H	approx. 1200 x 710 x 910 mm	approx. 860 x 680 x 910 mm
Weight	approx. 51 kg	approx. 41 kg

Scope of delivery: Steel frame with brakeable steering rollers and traversing slide with holder for length measuring device.

Technical data	MESSROL 1000 RM
Part No.	86180440
Coil-Ø / Spool-Ø	max. 1000 mm
Axle holder-Ø	30 mm
Traversing width	250 mm
L x W x H	approx. 1200 x 710 x 910 mm
Weight	approx. 35 kg

Scope of delivery: Steel frame with brakeable steering rollers.

Length measuring unit

Technical data	MESSBOI 25*
Part No.	85101000
Measuring range	2 - 25 mm
Display of counter	9999,99 m
L x W x H	approx. 120 x 160 x 350 mm
Error limit	+/- 0,5 %
Measuring wheel	aluminum with vulcanized PUR coating
Colour	RAL 7005 mouse grey
Weight	approx. 2,2 kg

Technical data	Inlet and outlet roller cage for MESSBOI 25
Part No.	85101001

Roller cage unit for better guidance of the winding goods.
Note: In combination with MESSROL 670 / 1000 the inlet and outlet roller cage unit is necessary.

* MESSBOI 25: Available with conformity assessment (formerly first calibration).
Conformity assessment of the length measuring device according module F1 with additional inlet and outlet roller cage is approved by German calibration authority. Valid for an unlimited period in the EEA. Conformity assessment has to be carried out in the manufacturing firm. Re-assessment after two years is not required, but maintenance by Kabelmat is recommended. **Only approved for useage in direct sales!**



Fig. 9: MESSROL 1000 base frame



Fig. 10: MESSROL 1000 RM base frame



Abb. 11: MESSBOI 25 with roller cage unit

MESSROL 670 / 1000

Coil and spool winder, manual

Length measuring device

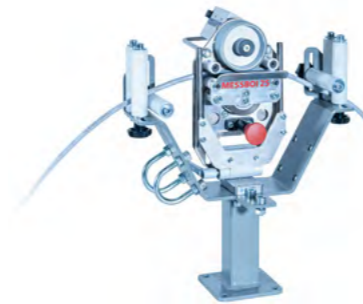
Technical data	MESSBOI 40 BAE*
Part No.	85100003
Measuring range	1 - 40 mm
Measuring range conformity assessed	2 - 25 mm
L x W x H (without roller cages)	approx. 320 x 320 x 280 mm
Display of counter	9999,99 m
Measuring wheel circumference	0,5 m
Error limit with roller cages due to class of accuracy III	+ / - 0,5 %
Weight	12 kg

* Note: MESSBOI 40 BAE is also available with stainless steel counter roller for wire rope or steel cable. Part No. 86000316.

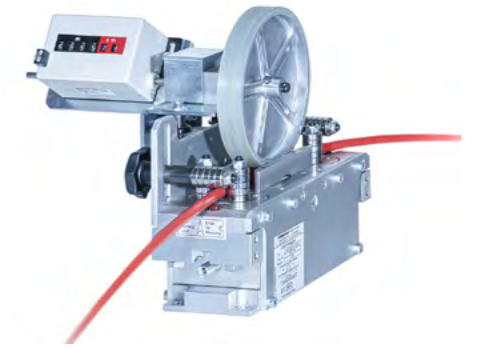

Fig. 12: MESSBOI 40 BAE length measuring device

Roller cages



Fig. 3 Inlet and outlet roller cages



Fig. 4 Inlet and outlet roller cages



Fig. 5 Inlet roller cage



Fig. 6 Inlet or outlet roller cage

Technical data	Inlet and outlet roller cages (pair)	Inlet and outlet roller cages (pair)	Inlet roller cage (piece)	Inlet or outlet roller cage (piece)
Part No.	85100185	85100186	85100189	86001454
Suitable for MESSBOI 40 BAE	✓	✓	✓	✓
For winding from an unwinder	✓	-	-	✓
For winding out of a drum rack	-	✓	✓	-
Rollers horizontal adjustable	✓	✓	✓	✓
Rollers horizontal and vertical adjustable	✓	✓	-	✓
Material-Ø	max. 40 mm	max. 40 mm	max. 40 mm	max. 40 mm
Guide outlet rollers-Ø	35 mm	35 mm	-	-
Guide inlet rollers-Ø	35 mm	80 mm	80 mm	35 mm
Weight	approx. 10 kg / pair	approx. 10 kg / pair	approx. 5 kg	approx. 5 kg
Housing	steel zinc-plated	steel zinc-plated	steel zinc-plated	steel zinc-plated
Guide rollers inlet	stainless steel	plastic	plastic	stainless steel
Guide rollers outlet	stainless steel	stainless steel	-	-

Conformity assessment

Technical data	Conformity assessment / MID (formerly first calibration)
Part No.	146

Conformity assessment of the length measuring device according module F1 with additional inlet and outlet roller cage is approved by German calibration authority. Valid for an unlimited period in the EEA. Conformity assessment has to be carried out in the manufacturing firm. Re-assessment after two years is not required, but maintenance by Kabelmat is recommended. **Only approved for useage in direct sales!**

MESSROL 670 / 1000

Coil and spool winder, manual

Cutting devices and accessory

Technical data	MATIS 25 M cutter	MATIS 35 cutter
Part No.	85100163	85100162
mounted on MESSBOI 40	✓	-
Material-Ø	max. 25 mm	max. 35 mm
Weight	approx. 4,9 kg	approx. 3,9 kg
Colour plastic cover	yellow	yellow
Note: not suitable for steel cables. *Only possible in combination with MESSBOI 40.		

Technical data	Holder for cutter MATIS 35
Part No.	85100558
mounted on base frame	✓
L x W x B	approx. 150 x 50 x 400 mm
Weight	approx. 2,5 kg
Colour	RAL 7005 mouse grey
Note: Not suitable for wire ropes.	

Technical data	MATIS 40 lever shear for cable (fine-wire)
Part No.	86001132
Material-Ø	max. 40 mm
B x W x H	approx. 110 x 130 x 720 mm
Weight	approx. 8,3 kg
Material	Blades made of oxide ceramics
Complete closed knife. Cut release via hand lever.	

Technical data	Alu profile for MESSBOI 40 for mounting onto MESSROL
Part No.	86100005
With mounting plates for roller cages, length measuring device, housing for counter and lever shear on MESSROL. Note: The length of the alu profile is adjusted according to the modular design.	

Technical data	Alu profile for MESSBOI 25 and MATIS 40 lever shear
Part No.	86100008

Spool winding axle with hand crank

Technical data	Spool winding axle 800 MB	Spool winding axle 800 RM
Part No.	85100435	85100555
Spool-Ø	max. 800 mm	max. 800 mm
Spool width	max. 395 mm (at bore 40 mm)	max. 430 mm (at bore 35 mm)
	max. 470 mm (at bore 80 mm)	max. 445 mm (at bore 50 mm)
		max. 475 mm (at bore 85 mm)
Spool bore-Ø	40 - 80 mm	35 - 85 mm
Axle holder-Ø	30 mm	30 mm
Axle-Ø	30 mm	30 mm
Colour	zinc-plated	zinc-plated
Load capacity	max. 60 kg	max. 100 kg
Weight	approx. 8 kg	approx. 10 kg
Driving pin	Ø 25 mm with an adjustment range of 80 - 170 mm	-



Fig. 18 MATIS 25 M (mounted)



Fig. 19 MATIS 35 (loose)



Fig. 20 Holder for MATIS 35



Fig. 21 MATIS 40



Fig. 22 Alu profile for MATIS 40



Fig.23 Spool winding axle 800 MB with driving pin



Fig.24 Spool winding axle 800 RM

MESSROL 670 / 1000

Coil and spool winder, manual

Coiler head with hand crank



Fig. 24: RAPID 600 SP



Fig. 25: RAPID 670 ST



Fig. 26: RAPID 480 SL



Fig. 27: RAPID 800 SL

Technical data	RAPID 600 SP
Part No.	85100091
Coil-Ø	max. 600 mm
Core-Ø (fixed core)	300 mm
Coil width	max. 120 mm
Load capacity	max. 25 kg
Axle holder-Ø	30 mm
Weight	approx. 8 kg
Colour	zinc-plated

Technical data	RAPID 480 ST	RAPID 670 ST	RAPID 850 ST*	RAPID 1000 ST*
Part No.	85100557	85100465	85100466	85100884
Coil-Ø	max. 480 mm	max. 670 mm	max. 850 mm	max. 1000 mm
Core adjusting range (in steps)	200/250/300/350 mm	250/400/500 mm	250/350/450/550/650 mm	250/350/450/550/650 mm
Coil width	80 - 250 mm	80 - 250 mm	80 - 250 mm	80 - 250 mm
Load capacity	max. 50 kg	max. 80 kg	max. 80 kg	max. 80 kg
Axle holder-Ø	30 mm	30 mm	30 mm	30 mm
Weight	approx. 25 kg	approx. 28 kg	approx. 32 kg	approx. 38 kg
Colour	RAL 3020 traffic red	RAL 3020 traffic red	RAL 3020 traffic red	RAL 3020 traffic red

Technical data	RAPID 480 SL	RAPID 800 SL*	RAPID 1000 SL*
Part No.	85100083	85100174	86001457
Coil-Ø	max. 480 mm	max. 800 mm	max. 1000 mm
Core adjusting range (stepless)	200 - 370 mm	300 - 550 mm	550 - 800 mm
Coil width	50 - 250 mm	50 - 250 mm	20 - 250 mm
Load capacity	max. 65 kg	max. 80 kg	max. 100 kg
Axle holder-Ø	30 mm	30 mm	30 mm
Weight	approx. 40 kg	approx. 70 kg	approx. 85 kg
Colour	RAL 3020 traffic red	RAL 3020 traffic red	RAL 3020 traffic red

*only in combination with MESSROL 1000.

Indoor use only.
Fig. may differ from original.
Technical modifications reserved.

MESSROL 500

Coil and spool winder, manual

Manual winder with a lot of working surface

Available with battery mode



Fig. 1 MESSBOI 40 BVE and high performance battery

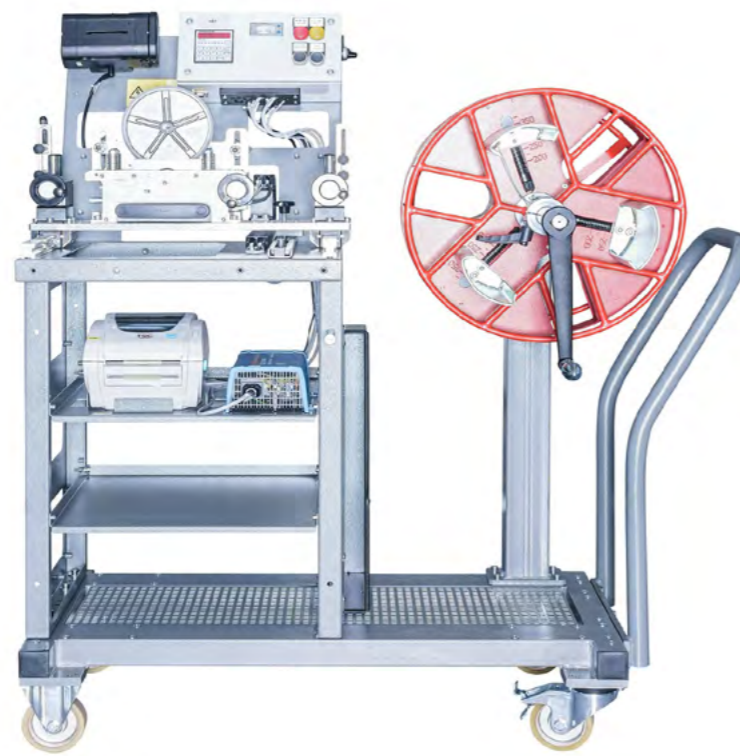

Fig. 2 MESSROL 500 with RAPID 480 SL, MESSBOI 40 LC-MID and battery mode

MESSROL 500

- Manual coil and spool winder

Functionality:

This manual coil and spool winder enables to wind winding material like cables, tubes, hoses, steel cables, plastic profiles etc. onto coils or empty spools and to simultaneously carry out length measuring and cutting. MESSROL 500 is optionally available with a high performance battery. This enables an especially flexible usage while maintaining power supply of the electronical components. In addition, MESSROL 500 offers a lot of working surface and is therefore a perfect allrounder in warehousing.

- Modular system
- Working surfaces for accessories, e.g. tools
- Easy winding while length measuring at the same time
- Movable traversing slide for a smooth winding pattern
- Easy assembly and removal of the coils and spools
- Optimal combination / supplement with unwinder or drum rack
- **Optional: also available with battery mode which enables a wireless energy supply of electronical components (mobility)**

Technical data	MESSROL 500
Part No.	0601.000
Coiler head / Spool-Ø	max. 500 mm
Spool width	max. 310 mm
Spool weight	max. 100 kg
Winding material-Ø (varying on conformity assessment)	1 - 30 mm
Traversing width	max. 340 mm
Inlet height	ca. 1000 mm
Running direction	both directions
L x W x H	approx. 1300 x 680 x 1300 mm
Colour	RAL 7005 mouse grey
Weight	approx. 200 kg

MESSROL 500

Coil and spool winder, manual

Basic equipment:

MESSROL 500 basic frame	Part No. 85100564
<ul style="list-style-type: none"> • Mobile device with two lockable steering rollers and two fixed rollers • Handle for a comfortable moving of the device • The winder is designed to admit winding head or spool winding axle • Manually operated traversing slide designed for accessories such as length measuring unit, cutting unit and guiding rollers • Working surface (e. g. for dropping rings or tools) 	
Manual cutting unit MATIS 40	Part No. 86001132
<ul style="list-style-type: none"> • For cutting the winding materials 	
Winding head RAPID 480 SL	Part No. 85100083
<ul style="list-style-type: none"> • For winding of coils 	
Spool winding axles 800 RB with quick-locking mechanism	Part No. 85100555
<ul style="list-style-type: none"> • For winding of spools 	
1:3 translation	Part No. 85100565
<ul style="list-style-type: none"> • For a more convenient winding of the spools 	

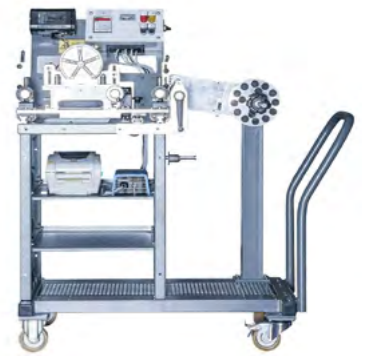

Fig. 3 MESSROL 500 with spool winding axle, MESSBOI 40 LC-MID with roller cages, conformity assessment, label printer, high-performance battery

Additional equipment:

<ul style="list-style-type: none"> • Length measuring unit MESSBOI 25 with mechanical counter for winding material up to 25 mm outer diameter • Error limit (incl. inlet and outlet roller cages) + / - 0,5 % 	Part No. 85101000
<ul style="list-style-type: none"> • Roller cages for a better guidance of the winding material 	Part No. 85101000
<ul style="list-style-type: none"> • Conformity assessment for direct sales - in the presence of the customer - (Module F1) 	Part No. 86101000
<ul style="list-style-type: none"> • Length measuring unit MESSBOI 40 BAE with mechanical counter for winding material up to 30 mm outer diameter • Error limit (incl. inlet and outlet roller cages) + / - 0,5 % 	Part No. 85100003
<ul style="list-style-type: none"> • Roller cages for a better guidance of the winding material 	Part No. 85100186
<ul style="list-style-type: none"> • Conformity assessment for direct sales - in the presence of the customer - (Module F1) 	Part No. 146
<ul style="list-style-type: none"> • Length measuring unit MESSBOI 40 LC / LC-MID with preselection counter and data memory for winding material up to 30 mm outer diameter • Error limit (incl. inlet and outlet roller cages) + / - 0,5 % • Preselection counter with disabling contacts 	Part No. 85100455
<ul style="list-style-type: none"> • Roller cages for a better guidance of the winding material 	Part No. 85100186
<ul style="list-style-type: none"> • Conformity assessment for factory sales - without presence of the customer - (Module F) 	Part No. 242
<ul style="list-style-type: none"> • Label printer with interface to the preselection counter 	Part No. 5101.000
<ul style="list-style-type: none"> • Console for the label printer 	Part No. 85100567
<ul style="list-style-type: none"> • Changeable high-performance battery 10 Ah for supplying energy to the preselection counter, data interface module and label printer without network connection (mobility) 	Part No. 85100566
<ul style="list-style-type: none"> • Charging cable 	Part No. 89929871



Fig. 4 MESSROL 500 Series

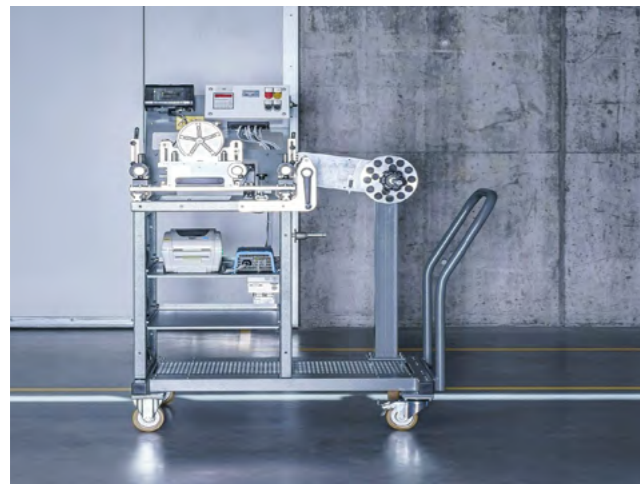

Fig. 5 MESSROL 500 with spool winding axle 800 RB, MESSBOI 40 LC-MID and battery mode



Fig. 6 MESSROL 500 with coiler head RAPID 480 SL, MESSBOI 40 LC-MID and battery mode

Technical data:

Cutting device

Technical data	MATIS 40 lever shear for cable (fine-wire)
Part No.	86001132
Material-Ø	max. 40 mm
B x W x H	approx. 110 x 130 x 720 mm
Weight	approx. 8,3 kg
Material	Blades made of oxide ceramics
Cut release via hand lever.	



Fig. 7 MATIS 40 lever shear

Technical data:

Coiler head with hand crank

Technical data	RAPID 480 SL
Part No.	85100083
Coil-Ø	max. 480 mm
Core adjusting range (continuously adjustable)	200 - 370 mm
Coil width	50 - 250 mm
Load capacity	max. 65 kg
Axle holder-Ø	30 mm
Weight	approx. 40 kg
Colour	RAL 3020 traffic red



Fig. 8 RAPID 480 SL

Technical data	RAPID 480 ST
Part No.	85100557
Coil-Ø	max. 480 mm
Core adjusting range (adjustable in steps)	200/250/300/350 mm
Coil width	80 - 250 mm
Load capacity	max. 50 kg
Axle holder-Ø	30 mm
Weight	approx. 25 kg
Colour	RAL 3020 traffic red



Fig. 9 RAPID 480 ST (Fig. similar)

Spool winding axle with hand crank

Technical data	Spool winding axle 800 MB	Spool winding axle 800 RM
Part No.	85100435	85100555
Spool-Ø	max. 800 mm	max. 800 mm
Spool width	max. 395 mm (at bore 40 mm)	max. 430 mm (at bore 35 mm)
	max. 470 mm (at bore 80 mm)	max. 445 mm (at bore 50 mm)
		max. 475 mm (at bore 85 mm)
Spool bore-Ø	40 - 80 mm	35 - 85 mm
Axle holder-Ø	30 mm	30 mm
Axle-Ø	30 mm	30 mm
Colour	zinc-plated	zinc-plated
Load capacity	max. 60 kg	max. 100 kg
Weight	approx. 8 kg	approx. 10 kg
Driving pin	Ø 25 mm with an adjustment range of 80 - 170 mm	-



Fig. 10 Spool winding axle 800 RM



Fig. 11 Spool winding axle 800 MB with driving pin

Technical data:

Length measuring device

Technical data	MESSBOI 25	MESSBOI 25 conformity assessment
Part No.	85101000	86101000
Measuring range	2 - 25 mm	2 - 15 mm
Display of counter	9999,99 m	9999,99 m
L x W x H	approx. 120 x 160 x 350 mm	approx. 120 x 160 x 350 mm
Error limit	+ / - 0,5 %	+ / - 0,5 %
Measuring wheel	aluminum with vulcanized PUR coating	aluminum with vulcanized PUR coating
Colour	aluminum / silver	aluminum / silver
Weight	approx. 1,4 kg	approx. 1,4 kg

Technical data	MESSBOI 40 BAE*
Part No.	85100003
Measuring range (with conformity assessment)	1 - 40 mm (2 - 25 mm)
L x W x H (without roller cages)	approx. 320 x 320 x 280 mm
Display of counter	9999,99 m
Measuring wheel extent	0,5 m
Error limit with roller cages according accuracy class III	+ / - 0,5 %
Weight	ca. 12 kg
Speed conformity assessed	max. 80 m / min

* Note: MESSBOI 40 BAE is also available with stainless steel counter roller for wire rope or steel cable. Part No. 86000316

Technical data	MESSBOI 40 LC / LC-MID
Part No.	85100455
With 2 potential-free change-over contact with pre-and limit switching	
Round cable-Ø with MID / conformity assessment	2 - 40 mm
Tube-Ø with MID / conformity assessment	2 - 40 mm
Steel cable-Ø with MID / conformity assessment	2 - 15 mm
Thickness range flat cable with MID / conformity assessment	2 - 15 mm
Width range flat cable with MID / conformity assessment	10 - 40 mm
Measuring wheel extent	0,5 m
Rotary pulse encoder	500 Imp / per turn 24 VDC
Error limit regarding accuracy class III (incl. inlet and outlet roller cages)	+ / - 0,5 %
Display of counter	99999,999 m
Speed with MID / conformity assessment	max. 250 m / min
L x W x H (without roller cages)	approx. 400 x 310 x 400 mm
Weight	approx. 10 kg



Fig. 12 MESSBOI 25 with inlet and outlet roller cages



Fig. 13 MESSBOI 40 BAE

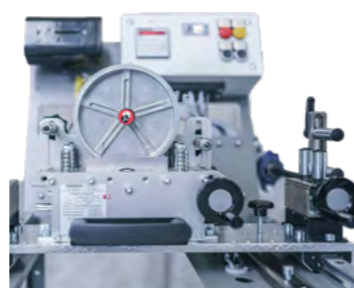

Fig. 14 MESSBOI 40 LC with inlet and outlet roller cages and battery mode

Technical data:

Roller cages

Technical data	Inlet and outlet roller cage unit for MESSBOI 25
Part No.	85101001
Roller cage unit for better guidance of the winding goods.	



Fig. 3 Inlet and outlet roller cages



Fig. 4 Inlet and outlet roller cages



Fig. 5 Inlet roller cage



Fig. 6 Inlet or outlet roller cage

Technical data	Inlet and outlet roller cages (pair)	Inlet and outlet roller cages (pair)	Inlet roller cage (piece)	Inlet or outlet roller cage (piece)
Part No.	85100185	85100186	85100189	86001454
Suitable for MESSBOI 40 BAE	✓	✓	✓	✓
For winding from an unwinder	✓	-	-	✓
For winding out of a drum rack	-	✓	✓	-
Rollers horizontal adjustable	✓	✓	✓	✓
Rollers horizontal and vertical adjustable	✓	✓	-	✓
Material-Ø	max. 40 mm	max. 40 mm	max. 40 mm	max. 40 mm
Guide outlet rollers-Ø	35 mm	35 mm	-	-
Guide inlet rollers-Ø	35 mm	80 mm	80 mm	35 mm
Weight	approx. 10 kg / pair	approx. 10 kg / pair	approx. 5 kg	approx. 5 kg
Housing	steel zinc-plated	steel zinc-plated	steel zinc-plated	steel zinc-plated
Guide rollers inlet	stainless steel	plastic	plastic	stainless steel
Guide rollers outlet	stainless steel	stainless steel	-	-

Conformity assessment

Technical data	Conformity assessment module F1
Part No.	146
Conformity assessment for direct sales due to module F1 (presence of the customer is required) with additional inlet and outlet roller cages is carried out by the German calibration authority valid unlimited for all European member states. Re-assessment is not necessary, a maintenance every 2 years by the manufacturer is recommended. Only authorised for use in direct sales!	

Technical data	Conformity assessment module F
Part No.	242
Conformity assessment for factory sales due to module F (presence of the customer not required) with additional inlet and outlet roller cages is carried out by the German calibration authority valid for a period of two years for all European member states. Conformity has to be carried out in the manufacturing firm. The re-assessment after two years is necessary, but not included in the scope of delivery. Required accessories: label printer (part no. 5101.000) and console for label printer (part no. 85100567)	

Indoor use only.
Fig. may differ from original.
Technical modifications reserved.

TISCHROL 450

Coil and spool winder, manual

Practical table winder



Fig. 1 TISCHROL Complete device TISCHROL 1:3 with spool winding axle

TISCHROL 450

- Manual coil and spool winder for small coils and spools

Functionality:

This manual coil and spool winder enables to wind winding material like cables, wires etc. into small coils or onto small spools. A main feature is an economic transmission ratio of 1:3.

- User-friendly hand winder
- Modular system
- Transmission ratio between rotary speed and winding speed 1:3
- Coiler head depending on coil size



Fig. 2 RAPID 450 SP folded for the removal of the coil



Fig. 3 RAPID 400 SP

Complete device

Technical data	TISCHROL 450 complete device
Part No.	85100012
Transmission ratio	1:3
Load capacity	max. 10 kg
Spool plate-Ø	300 mm
Spool width	165 mm (at bore 80 mm) 150 mm (at bore 50 mm) 135 mm (at bore 25 mm)
Axle holder-Ø	20 mm
Axle-Ø	16 x 200 mm
Colour pillar / Colour plate	RAL 7005 mouse grey / RAL 7035 light grey
L x W x H	approx. 300 x 445 x 410 mm
Weight	approx. 5,3 kg

Scope of delivery: Pillar, base plate and hand crank, plate with axle and centring cone. To ensure stable and user-friendly operation, we recommend that the base plate is always firmly fixed to the ground by means of screws. Screws are not included in the scope of delivery.



TISCHROL 450

Coil and spool winder, manual

Modular system

Possible combination:



Fig. 4 TISCHROL 1:1 base frame

+



Fig. 5 RAPID 450 SP

=



Fig. 6 TISCHROL 1:1 with RAPID 450 SP

Base frame

Technical data	TISCHROL 1:1	TISCHROL 1:3
Part No.	85100433	85100434
Transmission ratio	1:1	1:3
Axle holder-Ø	20 mm	20 mm
Dimension base plate to centre line	250 mm	250 mm
Coiler head-Ø / Spool-Ø	max. 450 mm	max. 450 mm
Weight	approx. 2,6 kg	approx. 3,8 kg
Colour	RAL 7005 mouse grey	RAL 7005 mouse grey
L x W x H	approx. 100 x 270 x 325 mm	approx. 100 x 270 x 295 mm

Scope of delivery: Pillar, base plate and hand crank. To ensure stable and user-friendly operation, we recommend that the base plate is always firmly fixed to the ground by means of screws. Screws are not included in the scope of delivery.

Coiler head with hand crank

Technical data	RAPID 400 SP	RAPID 450 SP
Part No.	85100089	85100090
Coil-Ø	max. 400 mm	max. 450 mm
Coil width	max. 70 mm	max. 70 mm
Core-Ø	130 mm	250 mm
Axle holder-Ø	max. 20 mm	max. 20 mm
Load capacity	max. 15 kg	max. 15 kg
Colour	zinc-plated	zinc-plated
Weight	approx. 4 kg	approx. 4,5 kg

Spool winding axle with hand crank

Technical data	Spool winding axle
Part No.	85100100
Load capacity	max. 10 kg
Spool plate-Ø	300 mm
Spool width	165 mm (at bore 80 mm) 150 mm (at bore 50 mm) 135 mm (at bore 25 mm)
Spool bore-Ø	25 - 80 mm
Axle holder-Ø	20 mm
Axle-Ø	16 x 200 mm
Colour	RAL 7035 light grey
Weight	approx. 1,5 kg
Scope of delivery:	Plate with axle and centring cone



Fig. 7 Spool winding axle

Indoor use only.
Fig. may differ from original.
Technical modifications reserved.



TISCHROL 1000

Coil and spool winder, manual

Practical table or stand winder

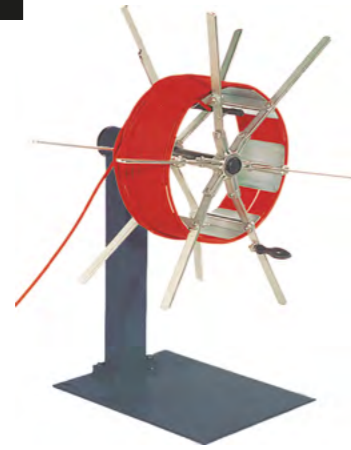

Fig. 1 TISCHROL 1000 with RAPID 600 SP



Fig. 2 TISCHROL 1000 H with RAPID 600 SP and MESSBOI 30 in combination with TROMBOI 500 mobile drum unwinder

TISCHROL 1000

Manual coil and spool winder

Functionality:

This manual coil and spool winder enables to wind winding material like cables, wires etc. into coils or onto empty spools. TISCHROL 1000 is available in two versions: table or stand winder

- User-friendly winder
- Modular system
- Easy assembly and removal of the coils and spools
- Length measurement possible

Modular system

Possible combination:



Fig. 3 TISCHROL 1000 base frame

+

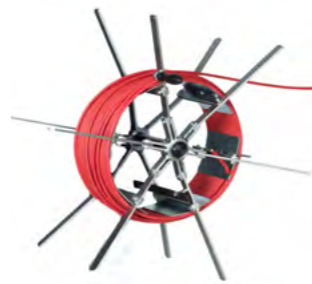

Fig. 4 RAPID 600 SP

=



Fig. 5 TISCHROL 1000 with RAPID 600 SP

TISCHROL 1000

Coil and spool winder, manual

Base frame

Technical data	TISCHROL 1000	TISCHROL 1000 H
Part No.	85100180	86003049
Coiler head-Ø / Spool-Ø	max. 1000 mm	max. 1000 mm
Axle holder-Ø	30 mm	30 mm
Transmission ratio	1:1	1:1
L x W x H	approx. 450 x 330 x 580 mm	approx. 450 x 330 x 1065 mm
Weight	approx. 20 kg	approx. 26 kg
Colour	RAL 7005 mouse grey	RAL 7005 mouse grey

Scope of delivery: pillar and base plate. To guarantee a stable and user-friendly operation, we recommend the fixing of the bottom plate by screwing it on the underground. Screws are not included in the scope of delivery.



Fig. 6 TISCHROL 1000

Coiler head with hand crank



Fig. 7 RAPID 600 SP



Fig. 8 RAPID 670 ST



Fig. 9 RAPID 480 SL



Fig. 10 RAPID 800 SL

Technical data	RAPID 600 SP
Part No.	85100091
Coil-Ø	max. 600 mm
Core-Ø (fixed core)	300 mm
Coil width	max. 120 mm
Load capacity	max. 25 kg
Axle holder-Ø	30 mm
Weight	approx. 8 kg
Colour	zinc-plated

Technical data	RAPID 480 ST	RAPID 670 ST	RAPID 850 ST	RAPID 1000 ST
Part No.	85100557	85100465	85100466	85100884
Coil-Ø	max. 480 mm	max. 670 mm	max. 850 mm	max. 1000 mm
Core adjusting range (in steps)	200/250/300/350 mm	250/400/500 mm	250/350/450/550/650 mm	250/350/450/550/650 mm
Coil width	80 - 250 mm	80 - 250 mm	80 - 250 mm	80 - 250 mm
Load capacity	max. 50 kg	max. 80 kg	max. 80 kg	max. 80 kg
Axle holder-Ø	30 mm	30 mm	30 mm	30 mm
Weight	approx. 25 kg	approx. 28 kg	approx. 32 kg	approx. 38 kg
Colour	RAL 3020 traffic red	RAL 3020 traffic red	RAL 3020 traffic red	RAL 3020 traffic red

Technical data	RAPID 480 SL	RAPID 800 SL	RAPID 1000 SL
Part No.	85100083	85100174	86001457
Coil-Ø	max. 480 mm	max. 800 mm	max. 1000 mm
Core adjusting range (stepless)	200 - 370 mm	300 - 550 mm	550 - 800 mm
Coil width	50 - 250 mm	50 - 250 mm	50 - 250 mm
Load capacity	max. 65 kg	max. 80 kg	max. 100 kg
Axle holder-Ø	30 mm	30 mm	30 mm
Weight	approx. 40 kg	approx. 70 kg	approx. 85 kg
Colour	RAL 3020 traffic red	RAL 3020 traffic red	RAL 3020 traffic red

TISCHROL 1000

Coil and spool winder, manual

Spool winding axle with hand crank



Fig. 11: Spool winding axle 800 MB with driving pin



Fig. 12: Spool winding axle 800 RM

Technical data	Spool winding axle 800 MB	Spool winding axle 800 RM
Part No.	85100435	85100555
Spool-Ø	max. 800 mm	max. 800 mm
Spool width	max. 395 mm (at bore 40 mm) max. 470 mm (at bore 80 mm)	max. 430 mm (at bore 35 mm) max. 445 mm (at bore 50 mm) max. 475 mm (at bore 85 mm)
Spool bore-Ø	40 - 80 mm	35 - 85 mm
Axle holder-Ø	30 mm	30 mm
Axle-Ø	30 mm	30 mm
Colour	zinc-plated	zinc-plated
Load capacity	max. 60 kg	max. 100 kg
Weight	approx. 8 kg	approx. 10 kg
Driving pin	Ø 25 mm with an adjustment range of 80 - 170 mm	-

Length measuring device and holder



Fig. 13: Holder for MESSBOI 10 / 25



Fig. 14: MESSBOI 10



Fig. 15: MESSBOI 25

Technical data	TISCHROL holder for length measuring device MESSBOI 10 / 25	Inlet and outlet roller cage unit with fixing device for MESSBOI 25
Part No.	85100542	85101001
Weight	approx. 3,5 kg	approx. 2,0 kg
L x W x H	approx. 630 x 365 x 360 mm	-
85101000	MESSBOI 10	MESSBOI 25*
Part No.	85100471	85101000
Measuring range	1 - 15 mm	2 - 25 mm
L x W x H	approx. 160 x 110 x 85 mm	approx. 120 x 160 x 350 mm
Display of counter	9999,99 m	9999,99 m
Error limit	+ / - 2 %	+ / - 0,5 %
Measuring force	Spring pressure	Spring pressure
Measuring wheel	Plastic	Aluminum with vulcanized PUR coating
Housing	Polystyrene	Aluminium
Colour	black / white	aluminum / silver
Weight	approx. 0,5 kg	approx. 1,4 kg

* MESSBOI 25: Available with conformity assessment (formerly first calibration). Conformity assessment of the length measuring device according module F1 with additional inlet and outlet roller cage is approved by German calibration authority. Valid for an unlimited period in the EEA. Conformity assessment has to be carried out in the manufacturing firm. Re-assessment after two years is not required, but maintenance by Kabelmat is recommended. **Only approved for useage in direct sales!**

RINGFIX / SPULFIX

Coil and spool unwinder, manual

Also available for tubes and plastic pipes



Fig. 1 RINGFIX TABLE with RINGFIX 480



Fig. 2 RINGFIX MOBILE with RINGFIX 480



Fig. 3 RINGFIX STATIONARY with RINGFIX 480

RINGFIX / SPULFIX

Manual coil and spool unwinder

Functionality:

This manual coil and spool unwinder enables to pull off material like cables, wires, tubes, plastic pipes etc. from coils or spools. Adjustable break mechanism avoid an uncontrolled material flow. Coils and spools rest with their dead weight centrally tensioned on the winding plates. A separate bouncing protection is the optimal addition to unwind tubes and plastic pipes easily.

- Twisting-free unwinding of the winding material
- Adjustable break mechanism at the base frame avoid an uncontrolled material flow
- Easy assembly and removal of the coils and spools
- Inside diameter continuously adjustable via core bolts and fixable in every position
- Optional: Bouncing protection for unwinding tubes or plastic pipes

Modular system

Possible combination:



Fig. 4 RINGFIX TABLE

+



Fig. 5 RINGFIX 480

=



Fig. 6 RINGFIX TABLE with RINGFIX 480

Base frame incl. break mechanism

Technical data	RINGFIX TABLE	RINGFIX MOBILE	RINGFIX STATIONARY
Part No.	85101513	85101514	85101515
Unwinding height	160 mm	825 - 975 mm	695 - 840 mm
L x W x H	approx. 520 x 520 x 102 mm	approx. 1045 x 1045 x 920 mm	approx. 880 x 880 x 790 mm
Plate-Ø	480 - 800 mm	480 - 800 mm	480 - 800 mm
Colour	RAL 7005 mouse grey	RAL 7005 mouse grey	RAL 7005 mouse grey
Weight	approx. 8,5 kg	approx. 32 kg	approx. 27 kg
With rollers (set)	-	✓	-

For coils



Fig. 5 RINGFIX TABLE with RINGFIX 480

For tube and plastic pipe coils



Fig. 6 RINGFIX TABLE with RINGFIX 480 and bouncing protection for tubes / plastic pipe

Coil unwinding plates

Technical data	RINGFIX 480	RINGFIX 650	RINGFIX 800
Part No.	85101509	85101510	85101511
Coil-Ø	max. 470 mm	max. 640 mm	max. 790 mm
Plate-Ø	480 mm	650 mm	800 mm
Height core bolts	250 mm	250 mm	250 mm
Core adjusting range	140 - 320 mm	180 - 500 mm	220 - 660 mm
Load capacity	max. 20 kg	max. 20 kg	max. 20 kg
Colour	zinc-plated	zinc-plated	zinc-plated
Weight	approx. 15 kg	approx. 46 kg	approx. 56 kg

Bouncing protection

- Border bolts and cover plate to avoid the bounce of the coil (e.g. for tubes and plastic pipes)

Technical data	for RINGFIX 480	for RINGFIX 650	for RINGFIX 800
Part No.	85101504	85101507	85101512
Cover plate-Ø	max. 480 mm	max. 650 mm	max. 800 mm
Incl. 5 border bolts	✓	✓	✓
Height border bolts	305 mm	305 mm	305 mm
Coil height	max. 230 mm	max. 230 mm	max. 230 mm
Weight	approx. 7,3 kg	approx. 10 kg	approx. 12,5 kg
Weight cover plate	approx. 3,3 kg	approx. 4,4 kg	approx. 5,4 kg
Colour cover plate	RAL 7005 mouse grey	RAL 7005 mouse grey	RAL 7005 mouse grey
Colour border bolts	zinc-plated	zinc-plated	zinc-plated

Spool unwinding plate

Technical data	SPULFIX 480
Part No.	85101516
Spool-Ø	max. 470 mm
Spool width	max. 150 mm
Plate-Ø	480 mm
Axle-Ø	16 x 200 mm
Centering cone for bore-Ø	25 - 80 mm
Load capacity	max. 20 kg
Colour	zinc-plated
Weight	approx. 5,5 kg



Fig. 7 SPULFIX 480

Complete devices

- for unwinding small coils and spools



Fig. 8 RINGFIX 300



Fig. 9 SPULFIX 300

Coil unwinder

Technical data	RINGFIX 300	RINGFIX 450
Part No.	85100004	85100005
Coil-Ø	max. 290 mm	max. 440 mm
Height core bolts	110 mm	110 mm
Core adjusting range	90 - 190 mm	150 - 250 mm
Plate-Ø	300 mm	450 mm
Load capacity	max. 10 kg	max. 12 kg
Colour	RAL 7035 light grey	RAL 7035 light grey
Weight	approx. 2,5 kg	approx. 4,5 kg

Spool unwinder

Technical data	SPULFIX 300	SPULFIX 450
Part No.	85100007	85100475
Spool-Ø	max. 290 mm	max. 440 mm
Spool height	max. 150 mm	max. 150 mm
Centering cone for bore-Ø	25 - 80 mm	25 - 80 mm
Axle-Ø	16 x 200 mm	16 x 200 mm
Load capacity	max. 10 kg	max. 12 kg
Colour	RAL 7035 light grey	RAL 7035 light grey
Weight	approx. 2,5 kg	approx. 4,5 kg

For heavy coils and spools



Fig. 1 KOMBITRAK 800 T with coiler head RAPID 800 SL



Fig. 2 Back side KOMBITRAK 800 T



Fig. 3 Back side KOMBITRAK 800 B



Fig. 4 Spool winding axle 800 MB



Fig. 5 Spool winding axle 800 RM

KOMBITRAK 800

- Manual coil and spool unwinder with mechanical brake or pendulum with rope brake

Functionality:

This manual coil and spool unwinder enables to unwind material like cables, wires etc. from coils or spools. Adjustable brake mechanism avoid an uncontrolled material flow.

- Twisting-free pull unwind the winding material
- Adjustable brake mechanism avoid an uncontrolled material flow
- Easy assembly and removal of the coils and spools
- Continuous and central tension of the coils

Base frame

Technical data	KOMBITRAK 800 B	KOMBITRAK 800 T
Part No.	87000305	85100912
Brake mechanism	with mechanical brake	with pendulum and rope brake
Winding head-Ø / Spool-Ø	max. 800 mm	max. 800 mm
Locating bore	30 mm	30 mm
Loading weight	max. 150 kg	max. 150 kg
L x W x H	approx. 1200 x 1000 x 1000 mm	approx. 1200 x 1000 x 1000 mm
Colour	RAL 7005 mouse grey	RAL 7005 mouse grey
Weight	approx. 70 kg	approx. 70 kg
Flow direction	both sides	from right to left

Coiler head without hand crank

Technical data	RAPID 480 SL	RAPID 800 SL
Part No.	85100082	85100101
Coil-Ø	max. 480 mm	max. 800 mm
Core adjusting range	200 - 370 mm	300 - 550 mm
Coil width	50 - 250 mm	50 - 250 mm
Load capacity	max. 65 kg	max. 80 kg
Axle holder-Ø	30 mm	30 mm
Weight	approx. 40 kg	approx. 70 kg
Colour	RAL 3020 traffic red	RAL 3020 traffic red

Spool winding axle without hand crank

Technical data	Spool winding axle 800 MB	Spoolwinding axle 800 RM
Part No.	85100103	87000224
Spool-Ø	max. 800 mm	max. 800 mm
Spool width	max. 395 mm (at bore 40 mm)	max. 430 mm (at bore hole 35 mm)
	max. 470 mm (at bore 80 mm)	max. 445 mm (at bore hole 50 mm)
		max. 475 mm (at bore hole 85 mm)
Core bore of the spool	40 - 80 mm	35 - 85 mm
Axle holder-Ø	30 mm	30 mm
Axle-Ø	30 mm	30 mm
Load capacity	max. 50 kg	max. 100 kg
Weight	approx. 8 kg	approx. 10 kg
Colour	zinc-plated	zinc-plated
Driving pin	Ø 25 mm with an adjustment range of 80 - 170 mm	-

RINGO 500

Coil and drum unwinder, manual

Perfect for building site



Fig. 1 RINGO 500 with cable coil



Fig. 2 RINGO 500 with cable drum



Fig. 3 RINGO 500 top part for drum

RINGO 500

- Universal manual coil and drum unwinder

Functionality:

This universal unwinder enables to unwind drums and coils twisting-free at the place of processing.

- Compact design
- Dynamic roll-off brake for a steady tensile force (braking effect is adapted to the supported weight)
- Low weight
- Small dimension
- Also suitable for damaged drums
- Maintenance-free
- Slipping-free
- Outdoor use possible

Technical data	RINGO 500
Part No.	85102215
Load weight	max. 380 kg
Coil outer-Ø	max. 500 mm
Coil inner-Ø	min. 120 mm
Drum bore	min. 50 mm
Weight	approx. 7 kg

TROMBOI 500 / 800 / 1400

Drum unwinder, manual

Compact design



Fig. 1 TROMBOI 500



Fig. 2 TROMBOI 500 MOBILE



Fig. 3 TROMBOI 800



Fig. 4 TROMBOI 1400

TROMBOI 500 - 1400

- Manual drum unwinder for drums from 140 to 1500 kg

Functionality :

These manual drum unwinders enables to unwind drums made from wood, steel, plastic easy and twist-free at the place of processing.

- Compact design
- Easy, twist-free unwinding of the drum
- High quality adjustable carrying rollers with ball bearings

Technical Data	TROMBOI 500	TROMBOI 500 MOBILE	TROMBOI 800	TROMBOI 1400
Part No.	85100910	85100915	85100009	85100010
Drum Ø	150 - 700 mm	150 - 700	400 - 1000 mm	500 - 1800 mm
Drum width	max. 520 mm	max. 520 mm	max. 580 mm	variable
Load capacity*	max. 140 kg	max. 140 kg	max. 500 kg	max. 1500 kg
Side guide rollers	-	-	2 pieces with ball bearings	2 pieces with ball bearings
Carrying rollers	-	-	2 pieces with double ball bearings	4 pieces with double ball bearings
Colour	RAL 7005 mouse grey	RAL 7005 mouse grey	zinc-plated	zinc-plated
L x W x H	approx. 550 x 530 x 80 mm	approx. 550 x 530 x 200 mm	approx. 700 x 700 x 140 mm	approx. 760 x 270 x 140 mm
Weight	approx. 8 kg	approx. 10 kg	approx. 21 kg	approx. 27 kg (pair)
Brakeable steering rollers (set)	-	✓	-	-

*Load capacity is only valid for non-continuous unwinding with undamaged drums.

Accessories	Brakeable steering rollers (set = 4 pieces) for TROMBOI 500
Part No.	85100911
Weight	approx. 1,7 kg

TROMBOI 7-10 / 9-14

Drum unwinder, manual



Fig. 1 TROMBOI 7-10 with drum sample



Fig. 2 TROMBOI 7-10

TROMBOI 7-10 / 9-14

- Manual drum unwinder for drums max. 1000 kg / max. 1700 kg

Functionality:

These manual drum unwinders enable to unwind the drums easy and twisting-free at the place of processing. These unwinders are qualified for drums made from wood, steel and plastics.

- Due to axle bearing only low tensile force is needed
- Also suitable for drums with damaged drum flange (unwinding performance will not be affected due to axle bearing)
- High stability via largely dimensioned base plates
- Easy lifting of the drum via lever mechanism
- Stabil steel welded construction

High stability

Technical Data	TROMBOI 7-10	TROMBOI 9-14
Part No.	85005031	85005041
Drum-Ø	710 - 1000 mm	900 - 1400 mm
Drum axle with cones	no.1 Ø 34 x 840 mm	no. 3 Ø 60 x 1140 mm
Load capacity	max. 1000 kg	max. 1700 kg
L x W	approx. 500 x 240 mm	approx. 600 x 250 mm
Height adjustable	420 - 600 mm	700 - 830 mm
Colour	RAL 7005 mouse grey	RAL 7005 mouse grey
Weight with axle and cones	approx. 32 kg / pair	approx. 51 kg / pair

Accessories	Additional drum axle		
Part No.	Description	for TROMBOI 7-10	for TROMBOI 9-14
85008010	Drum axle no. 1 Ø 34 x 840 mm Load capacity max. 1000 kg	✓	✓
85008020	Drum axle no. 2 Ø 34 x 1140 mm Load capacity max. 700 kg	✓	✓
85008030	Drum axle no. 3 Ø 60 x 1140 mm Load capacity max. 1700 kg	-	✓
85008040	Drum axle no. 4 Ø 60 x 1340 mm Load capacity max. 2000 kg	-	✓

TROMBOI 2003

Drum unwinder, manual



Fig. 1 TROMBOI 2003 with drum sample



Fig. 2 TROMBOI 2003

TROMBOI 2003

- Manual drum unwinder with hydraulic hand pump for drums max. 4000 kg

Functionality:

The manual drum unwinder enables to unwind the drums easy and twisting-free at the place of processing. This unwinder is qualified for drums made from wood, steel and plastics.

- Particularly suitable for heavy drums
- Also suitable for drums with damaged drum flange (unwinding performance will not be affected due to axle bearing)
- Due to axle bearing only low tensile force is needed
- Easy lifting of the drum via hand hydraulic pump
- Lowering of the drum via vent screw
- Stabil steel welded construction

For heavy drums



Fig. 3 Hydraulic hand pump

Technical data	TROMBOI 2003
Part No.	85005091
Drum-Ø	900 - 2000 mm
Drum axle no. 6 with adjustment ring	Ø 76 x 1700 mm
Load capacity	max. 4000 kg
L x W x H	approx. 550 x 300 x 1520 mm
Colour	RAL 7005 mouse grey
Weight with axle and cones	approx. 132 kg / pair

Accessories	Additional drum axle
Part No.	Description
85008020	Drum axle no. 2 Ø 34 x 1140 mm Load capacity max. 700 kg
85008030	Drum axle no. 3 Ø 60 x 1140 mm Load capacity max. 1700 kg
85008040	Drum axle no. 4 Ø 60 x 1340 mm Load capacity max. 2000 kg
85008060	Drum axle no. 6 Ø 76 x 1700 mm Load capacity max. 4000 kg

TROMTRAK 1250

Drum unwinder, manual

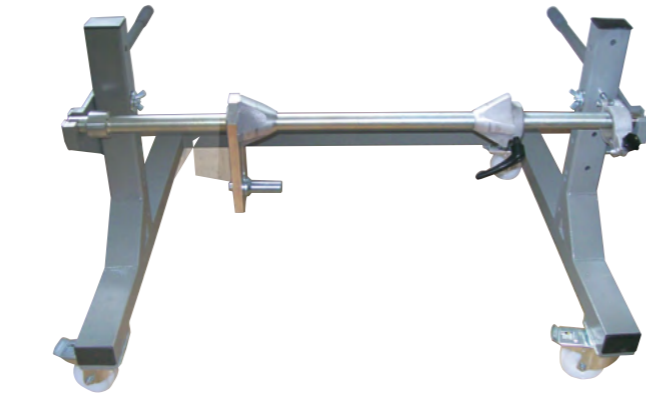
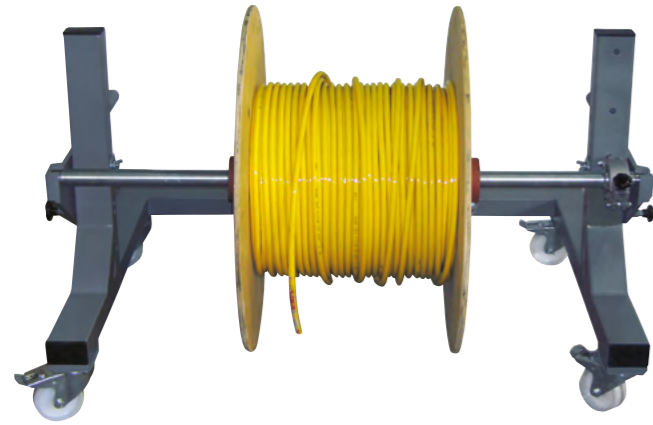

Fig. 1 TROMTRAK 1250 with drum sample incl. axles with centering cones

Fig. 2 TROMTRAK 1250 incl. adjustable driving pin

TROMTRAK 1250

- Manual drum unwinder with adjustable brake

Functionality:

The manual drum unwinders enables to unwind the drums easy and twisting-free at the place of processing. This unwinder is qualified for drums made from wood, steel and plastics and a perfect addition to a Kabelmat cutting automat.

- Suitable for usage in a mechanical processing line
- Base frame with brakeable driving wheels
- Drum axle with adjustable shoe brake
- Double bearing axle
- Stabil steel welded construction

Technical data	TROMTRAK 1250 with centering cones	TROMTRAK 1250 with driving pin Ø 25mm	TROMTRAK 1250 with driving pin Ø28 mm
Part No.	85100011	85100581	85100582
Drum-Ø	630 - 1250 mm	630 - 1250 mm	630 - 1250 mm
Drum axle-Ø	34 mm	34 mm	60 mm
Load capacity	max. 250 kg	max. 250 kg	max. 500 kg
Drum width	max. 890 mm	max. 730 mm (at bore 40 mm) max. 810 mm (at bore 80 mm)	max. 880 mm (at bore 80 mm)
L x W x H	approx. 860 x 1300 x 720 mm	approx. 860 x 1300 x 720 mm	approx. 860 x 1300 x 720 mm
Colour	RAL 7005 mouse grey	RAL 7005 mouse grey	RAL 7005 mouse grey
Weight	approx. 50 kg	approx. 50 kg	approx. 60 kg
Adjustment range driving pin	-	80 - 170 mm	100 - 300 mm

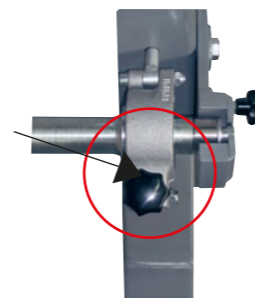

Fig. 3 Shoe brake

Indoor use only.
Fig. may differ from original.
Technical modifications reserved.

TROMCAR 1000 / 1250

Unwinder and transport device for drums, manual



Fig. 1 TROMCAR 1000

Fig. 2 TROMCAR 1250

TROMCAR 1000 / 1250

- Manual unwinder and transport device for drums

Functionality:

These especially robust manual unwinding and transport systems are used for the in-house transport; they can be used to transport drums and unwind them at the processing site.

- Flexible usage
- Large heavy-duty rollers
- All steel welded construction
- Optional measuring device possible

Technical data	TROMCAR 1000	TROMCAR 1250
Part No.	85006002	85006003
Drum-Ø	500 - 1000 mm	500 - 1250 mm
Drum axle with centering cones	no. 1 Ø 34 x 840 mm	no. 2 Ø 34 x 1140 mm
Load capacity	max. 1000 kg	max. 700 kg
Drum width	max. 710 mm	max. 1000 mm
L x W x H	approx. 1600 x 1040 x 770 mm	approx. 1600 x 1360 x 830 mm
Colour	RAL 7005 mouse grey	RAL 7005 mouse grey
Weight	approx. 50 kg	approx. 52 kg
Equipment	2 fixed rollers 2 pillars	2 fixed rollers 1 steering roller

Equipment	Description
85101001*	Inlet and outlet roller cage unit with fixing device for MESSBOI 25
85101000	MESSBOI 25 length measuring device for measuring range 2 - 25 mm
86101000	MESSBOI 25 length measuring device conformity assessed for measuring range 2 - 15 mm

*Note: In combination with TROMCAR 1000 / 1250 the inlet and outlet roller cage unit is necessary.



Abb. 3: MESSBOI 25 with roller cage unit and mounting device

Indoor use only.
Fig. may differ from original.
Technical modifications reserved.

MACHINE WINDING TECHNOLOGY



PRODUCTS

• AUTOCUT 40	48
• MOTROL 500	50
• MOTROL 800 EASY	52
• MOTROL 800	54
• MOTROL 1000	56
• RINGROL 600	58
• RINGROL 800	60
• RINGROL 1200	62
• UMROL 1000 AUF	64
• UMROL 1400 / 1600 / 2200 AUF	66
• PORTROL 1000 / 1400 AUF	69
• PORTROL 1000 / 1400 ABW	71
• TROMPIN 800 / 1250	73
• SPULFIX 480	74
• TROMTRAK 1600	76
• TROMROL 2500	77
• SIGNOMAT	78

AUTOCUT 40

Length cutting machine

Easy operation -
Exact cutting



Fig. 1 AUTOCUT 40 with closed protection cover

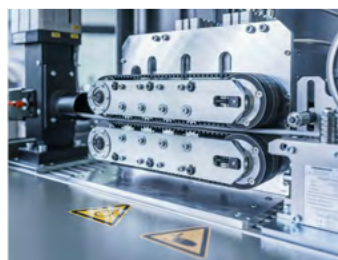

Fig. 2 Installation with a calibratable length measuring device, belt feed and pneumatic cable cutter



Fig. 3 Control panel with touch panel control and regulated positioning servo drive



Fig. 4 AUTOCUT 40 with open protective cover



Fig. 5 Pot winder with adjustable drive motor

AUTOCUT 40

- Cutting machine for cables, pipes, hoses and more

Functionality:

This motorised length cutting machine is suitable for measuring and cutting to length materials such as cables, pipes, hoses, steel ropes, plastic profiles etc. The powerful feed allows the draw-off directly from an unwinding system without motor such as drum rack or drum unwinder. In connection with a coil pin the cut-off materials are coiled in rings.

Technical Data	AUTOCUT 40
Part No.	1284.000
Winding material-Ø	1 - 30 mm
Inlet height	approx. 1000 mm
Running direction	right to left
L x W x H	approx. 1160 x 950 x 1550 mm
Height with open protection cover	approx. 2050 mm
Length with pot winder	approx. 1800 mm
Colour	RAL 7005 mouse grey
Weight (without accessories)	approx. 350 kg

AUTOCUT 40

Length cutting machine

Basic equipment:

- Basic machine constructed as self-supported, torsionally resistant weldment with two lockable and two fixed steering rollers or four lockable steering rollers
- Speed control is continuously adjustable, allowing a smooth starting
- The control cabinet is installed in the machine frame
- The control panel with emergency stop button is ergonomically integrated in the base frame
- Protection cover with window to be hinged upwards (required for CE)
- CE conformity declaration according to machinery directive 2006/42/EG
- **Roller cage** before the length measuring unit, easily adjustable to match the material
- **Length measuring device MESSBOI 40 LC / LC-MID** with preselection counter
 - Error limit (with in-and outlet roller cages) + / - 0,5 %
 - Pre-selection counter with disconnecting contact of the drive

Recommended equipment:

- **Pneumatically or hydraulically operated cutting** system for cutting the winding material.
- **Roller feed** as a transport- and positioning unit
 - Rubber plated high resistant drive rollers with non-return safety device
 - Lifting and lowering of the top roller unit via push button
 - Contact pressure manually adjustable by a pressure controller
 - Drive of the lower transport roller by the speed-controlled geared motor
 - Feeding speed max. 30 m / min
 - Tensile force approx. 120 N
- **Alternative belt feed**
 - Lifting and lowering of the top belt unit via push button
 - Contact pressure manually adjustable by a pressure controller
 - Drive of both belts by means of a speed-controlled geared motor with retractable precision drive shafts
 - Feeding speed max. 55 m / min
 - Tensile force approx. 500 N
- **Coil pin motorized** size of the coil pins is selectable.
- **Printer head holder and guide for inkjet printer** with fine adjustment in the X and Y axis
 - **Second rotary pulse** for Inkjet-printersystem
 - **Straightening unit** adjustable by hand
- **Conformity assessment / MID (formerly first calibration)**
 - **Automatic storage** of the cutting data
 - **Label printer** with interface to the preselection counter
 - **Conformity assessment** to module F (in accordance with the European Measuring Instruments Directive 2014/32/EU) of the length measuring device with additional inlet and outlet roller cages by the German calibration authority. **Valid for a period of two years** for all member states of the EEA. The assessment is carried out in the manufacturer's factory. **Calibration after two years is required**, but is not included in the scope of delivery. Note: Conformity assessment according to module F (formerly first calibration) is required when the **customer is not present** during the cutting of the material (cables ect.). **Required:** Storage of the cutting data and documentation on the business records.

Further auxiliary equipment on request

Compact winding machine with high operating comfort



Fig. 1 MOTROL 500



Fig. 2 Coiler head 480SL



Fig. 3 Spool winding axle



Fig. 4 Label printer



Fig. 5 Label sample

MOTROL 500

- Coil and spool winding machine for coiler head / spool-Ø max. 500 mm

Functionality:

This motor-driven coil and spool winder enables to wind winding material like cables, tubes, hoses, steel cables, plastic profiles etc. onto coils or empty spools and to simultaneously carry out length measuring and cutting.

Technical Data	MOTROL 500
Part No.	0674.000
Winding material-Ø (depending on material)	2 - 30 mm
Coiler head / spool-Ø	max. 500 mm
Spool width (depending on type of spool winding axle)	max. 290 mm
Spool weight (depending on type of spool winding axle)	max. 100 kg
Winding drives selectable (depending on requirements)	140 rpm (075 kW) or 240 rpm (1,5 kW)
Electrical connection	230 V / 50 Hz or 400 V / 50 Hz
Traversing width	max. 270 mm
Inlet height	approx. 1100 mm
Pass-through direction	right to left
L x W x H	approx. 1500 x 900 x 1400 mm
Length with open protection cover	approx. 2100 mm
Colour machine	RAL 7005 mouse grey
Weight machine (without packing)	approx. 290 kg

Basic equipment:

- Basic machine constructed as self-supported, torsionally resistant weldment with two lockable and two fixed steering rollers or four lockable steering rollers
- Drive by means of AC-gear motor via chain
- Speed control is continuously adjustable, allowing a smooth starting
- The winder is designed for winding heads, ring coiler heads or spool winding axles
- Manually operated traversing slide designed for accessories such as length measuring units, cutting units and guide rollers
- The control cabinet is installed in the machine frame
- The control panel with emergency stop button is ergonomically integrated in the base frame
- Protection cover with window to be slid sideways (required for CE)
- CE conformity declaration according to machinery directive 2006/42/EG
- **Roller cages** before and behind the length measuring unit, easily adjustable to match the material. Various models available depending on the requirements
- **Length measuring device MESSBOI 40 LC / LC-MID or MESSBOI 40 B LC / LC-MID**
 - Error limit (with in- and outlet roller cages) + / - 0,5 %
 - Pre-selection counter with disconnecting contact of the drive

Recommended equipment:

- **Automatic traversing** consisting of gear motor with speed controller Traversing can be moved to any position via joystick. This is important for the starting position of the winding drive. The motion reversing points can be stored via reference keys during machine downtime but also during winding operation. In usage of round winding material the traversing pitch adapts automatically via diameter detection, but is also adjustable via rotary potentiometer during the winding operation. In case of winding flat material there is no diameter detection function. The traversing pitch has to be adjusted continuously via rotary potentiometer during the winding operation. The traversing speed automatically adapts to the winding speed (synchronization). The complete traversing drive can be disengaged for manual traversing.
- **Manual or pneumatic operated cutting system** for cutting the winding material
- **Roller feed** in support of cutting process and in connection with pneumatic cutting device for additional operation mode „cut to length without winding process“
- **Coiler head** for winding of coils. Various models available
- **Spool winding axle** with quick-locking mechanism and frictional driver for winding of spools. Various sizes available
- **Conformity assessment / MID (formerly first calibration)**
 - **Automatic storage** of the cutting data
 - **Label printer** with interface to the preselection counter
 - **Conformity assessment** to module F (in accordance with the European Measuring Instruments Directive 2014/32/EU) of the length measuring device with additional inlet and outlet roller cages by the German calibration authority. **Valid for a period of two years** for all member states of the EEA. The assessment is carried out in the manufacturer's factory. **Calibration after two years is required**, but is not included in the scope of delivery. Note: Conformity assessment according to module F (formerly first calibration) is required when the **customer is not present** during the cutting of the material (cables ect.). **Required:** Storage of the cutting data and documentation on the business records.

Further auxiliary equipment on request

MOTROL 800 EASY

Coil and spool winding machine

Take it Easy.
Smart entry-level model



Fig. 1 MOTROL 800 EASY



Fig. 2 Coiler head RAPID 800 SL



Fig. 3 Spool winding axle



Fig. 4 Label printer



Fig. 5 Label sample

MOTROL 800 EASY

- Coil and spool winding machine for coiler head / spool-Ø max. 800 mm

Functionality:

This motor-driven coil and spool winder enables to wind winding material like cables, tubes, hoses, steel cables, plastic profiles etc. onto coils or empty spools and to simultaneously carry out length measuring and cutting.

Technical Data	MOTROL 800 EASY
Part No.	0676.000
Winding material-Ø (depending on material)	2 - 30 mm
Coiler head / spool-Ø	max. 800 mm
Spool width (depending on type of spool winding axle)	max. 310 mm
Spool weight (depending on type of spool winding axle)	max. 100 kg
Winding drive	70 rpm (0,75 kW)
Electrical connection	230 V / 50 Hz
Traversing width	max. 300 mm
Inlet height	approx. 1080 mm
Pass-through direction	right to left
L x W x H	approx. 1800 x 850 x 1400 mm
Height with open protection cover	approx. 2000 mm
Colour machine	RAL 7005 mouse grey
Weight machine (without packing)	approx. 300 kg

MOTROL 800 EASY

Coil and spool winding machine

Basic equipment:

- Basic machine constructed as self-supported, torsionally resistant weldment with two lockable and two fixed steering rollers or four lockable steering rollers
- Drive by means of AC-g geared motor via chain
- Speed control is continuously adjustable, allowing a smooth starting
- The winder is designed for winding heads, ring coiler heads or spool winding axles
- **Manually operated traversing slide** designed for accessories such as length measuring units, cutting units and guide rollers
- The control cabinet is installed in the machine frame
- The control panel with emergency stop button is ergonomically integrated in the base frame
- Protection cover with window to be hinged upwards (required for CE)
- CE conformity declaration according to machinery directive 2006/42/EG
- **Roller cages** before and behind the length measuring unit, easily adjustable to match the material
- **Length measuring device MESSBOI 40 LC / LC-MID**
 - Error limit (with in- and outlet roller cages) + / - 0,5 %
 - Pre-selection counter with disconnecting contact of the drive

Recommended equipment:

- **Manual operated cutting system** for cutting the winding material

- **Coiler head** for winding of coils.
Various models available

- **Spool winding axle** with quick-locking mechanism and frictional driver for winding of spools.
Various sizes available

Conformity assessment / MID (formerly first calibration)

- **Automatic storage** of the cutting data
- **Label printer** with interface to the preselection counter
- **Conformity assessment** to module F (in accordance with the European Measuring Instruments Directive 2014/32/EU) of the length measuring device with additional inlet and outlet roller cages by the German calibration authority. **Valid for a period of two years** for all member states of the EEA. The assessment is carried out in the manufacturer's factory. **Calibration after two years is required**, but is not included in the scope of delivery. Note: Conformity assessment according to module F (formerly first calibration) is required when the **customer is not present** during the cutting of the material (cables ect.). **Required:** Storage of the cutting data and documentation on the business records.

Further auxiliary equipment on request

Winding machine
for professionals



Fig. 1 MOTROL 800



Fig. 2 Coiler head RAPID 800 SL



Fig. 3 Spool winding axle



Fig. 4 Label printer



Fig. 5 Label sample

MOTROL 800

- Coil and spool winding machine for coiler head / spool-Ø max. 800 mm

Functionality:

This motor-driven coil and spool winder enables to wind winding material like cables, tubes, hoses, steel cables, plastic profiles etc. onto coils or empty spools and to simultaneously carry out length measuring and cutting.

Technical data	MOTROL 800
Part No.	0715.000
Winding material-Ø (depending on material)	2 - 60 mm
Coiler head / spool-Ø	max. 800 mm
Spool width (depending on type of spool winding axle)	max. 425 mm
Spool weight (depending on type of spool winding axle)	max. 100 kg
Winding drives selectable (depending on requirements)	95 rpm (1,5 kW) or 130 rpm (3,0 kW)
Electrical connection	400 V / 50 Hz
Traversing width	max. 400 mm
Inlet height	approx. 1140 mm
Pass-through direction	right to left
L x W x H	approx. 2000 x 1000 x 1400 mm
Height with open protection cover	approx. 2150 mm
Colour machine	RAL 7005 mouse grey
Weight machine (without packing)	approx. 500 kg

Basic equipment:

- Basic machine constructed as self-supported, torsionally resistant weldment with two lockable and two fixed steering rollers or four lockable steering rollers
- Drive by means of AC-gear motor via chain
- Speed control is continuously adjustable, allowing a smooth starting
- The winder is designed for winding heads, ring coiler heads or spool winding axles
- Manually operated traversing slide designed for accessories such as length measuring units, cutting units and guide rollers
- The control cabinet is installed in the machine frame
- The control panel with emergency stop button is ergonomically integrated in the base frame
- Protection cover with window to be hinged upwards (required for CE)
- CE conformity declaration according to machinery directive 2006/42/EG
- **Roller cages** before and behind the length measuring unit, easily adjustable to match the material.
Various models available depending on the requirements
- **Length measuring device MESSBOI 40 LC / LC-MID, MESSBOI 40 B LC / LC-MID or MESSBOI 80 LC / LC-MID**
 - Error limit (with in-and outlet roller cages) + / - 0,5 %
 - Pre-selection counter with disconnecting contact of the drive

Recommended equipment:

- **Automatic traversing** consisting of gear motor with speed controller Traversing can be moved to any position via joystick. This is important for the starting position of the winding drive. The motion reversing points can be stored via reference keys during machine downtime but also during winding operation. In usage of round winding material the traversing pitch adapts automatically via diameter detection, but is also adjustable via rotary potentiometer during the winding operation. In case of winding flat material there is no diameter detection function. The traversing pitch has to be adjusted continuously via rotary potentiometer during the winding operation. The traversing speed automatically adapts to the winding speed (synchronization). The complete traversing drive can be disengaged for manual traversing.
- **Manual, pneumatic or hydraulic operated cutting system** for cutting the winding material
- **Roller feed** in support of cutting process and in connection with pneumatic cutting device for additional operation mode "Cut to length without winding process"
- **Coiler head** for winding of coils.
Various models available
- **Spool winding axle** with quick-locking mechanism and frictional driver for winding of spools.
Various sizes available
- **Conformity assessment / MID (formerly first calibration)**
 - **Automatic storage** of the cutting data
 - **Label printer** with interface to the preselection counter
 - **Conformity assessment** to module F (in accordance with the European Measuring Instruments Directive 2014/32/EU) of the length measuring device with additional inlet and outlet roller cages by the German calibration authority. **Valid for a period of two years** for all member states of the EEA. The assessment is carried out in the manufacturer's factory. **Calibration after two years is required**, but is not included in the scope of delivery. Note: Conformity assessment according to module F (formerly first calibration) is required when the **customer is not present** during the cutting of the material (cables ect.). **Required:** Storage of the cutting data and documentation on the business records.

Further auxiliary equipment on request

Winding machine in a perfect combination



Fig. 1 MOTROL 1000



Fig. 2 Coiler head RAPID 1000 SL



Fig. 3 Lift-type device for drums



Fig. 4 Label printer



Fig. 5 Label sample

MOTROL 1000

- **Coil and spool winding machine for coiler head / drum-Ø max. 1000 mm**

Functionality:

This motor driven coil and spool winder enables to wind materials such as cables, tubes, hoses, steel cables, plastic profiles etc. onto coils or empty spools and to simultaneously carry out length measuring and cutting. The wound spools resp. drums can be removed with a lift-type device (Fig.3)

Technical data	MOTROL 1000
Part No.	0705.000
Winding material-Ø (depending on material)	2 - 60 mm
Coiler head / drum-Ø	max. 1000 mm
Drum width (depending on type of drum winding axle)	max. 710 mm
Drum weight (depending on type of drum winding axle)	max. 350 kg
Winding drives selectable (depending on requirements)	75 rpm (1,5 kW) or 130 rpm (3,0 kW)
Electrical connection	400 V / 50 Hz
Traversing width	max. 650 mm
Inlet height	approx. 1140 mm
Pass-through direction	right to left
L x W x H	approx. 2200 x 1400 x 1500 mm
Height with open protection cover	approx. 2450 mm
Colour machine	RAL 7005 mouse grey
Weight machine (without packing)	approx. 700 kg

Basic equipment:

- Basic machine constructed as self-supported, torsionally resistant weldment with two lockable and two fixed steering rollers or four lockable steering rollers
- Drive by means of AC-g geared motor via chain
- Speed control is continuously adjustable, allowing a smooth starting
- The winder is designed for winding heads, ring coiler heads or spool winding axles
- Manually operated traversing slide designed for accessories such as length measuring units, cutting units and guide rollers
- The control cabinet is installed in the machine frame
- The control panel with emergency stop button is ergonomically integrated in the base frame
- Protection cover with window to be hinged upwards (required for CE)
- CE conformity declaration according to machinery directive 2006/42/EG
- **Roller cages** before and behind the length measuring unit, easily adjustable to match the material. Various models available depending on the requirements
- **Length measuring device MESSBOI 40 LC / LC-MID, MESSBOI 40 LC / LC-MID or MESSBOI 80 LC / LC-MID**
 - Error limit (with in-and outlet roller cages) + / - 0,5 %
 - Pre-selection counter with disconnecting contact of the drive

Recommended equipment:

- **Automatic traversing** consisting of gear motor with speed controller Traversing can be moved to any position via joystick. This is important for the starting position of the winding drive. The motion reversing points can be stored via reference keys during machine downtime but also during winding operation. In usage of round winding material the traversing pitch adapts automatically via diameter detection, but is also adjustable via rotary potentiometer during the winding operation. In case of winding flat material there is no diameter detection function. The traversing pitch has to be adjusted continuously via rotary potentiometer during the winding operation. The traversing speed automatically adapts to the winding speed (synchronization). The complete traversing drive can be disengaged for manual traversing.
- **Manual, pneumatic or hydraulic operated cutting system** for cutting the winding material
- **Roller feed** in support of cutting process and in connection with pneumatic cutting device for additional operation mode "Cut to length without winding process"
- **Coiler head incl. adapter** for winding of coils. Various models available
- **Spool winding axle** with quick-locking mechanism and frictional driver for winding of spools. Various sizes available
- **Lift-type device for drums**
Moveable device for lifting and lowering of full and empty drums at the flange from the floor.
- **Conformity assessment / MID (formerly first calibration)**
 - **Automatic storage** of the cutting data
 - **Label printer** with interface to the preselection counter
 - **Conformity assessment** to module F (in accordance with the European Measuring Instruments Directive 2014/32/EU) of the length measuring device with additional inlet and outlet roller cages by the German calibration authority. **Valid for a period of two years** for all member states of the EEA. The assessment is carried out in the manufacturer's factory. **Calibration after two years is required**, but is not included in the scope of delivery. Note: Conformity assessment according to module F (formerly first calibration) is required when the **customer is not present** during the cutting of the material (cables ect.). **Required:** Storage of the cutting data and documentation on the business records.

Further auxiliary equipment on request

Coil winding made easy



Fig. 1 RINGROL 600 with open cover and binding device

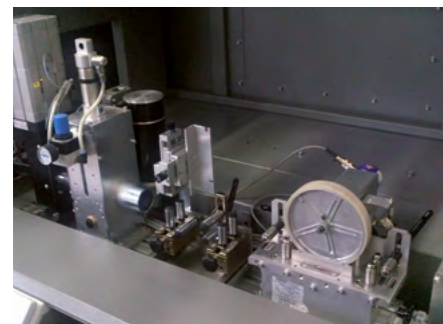

Fig. 2 Example traversing unit



Fig. 3 Winding unit

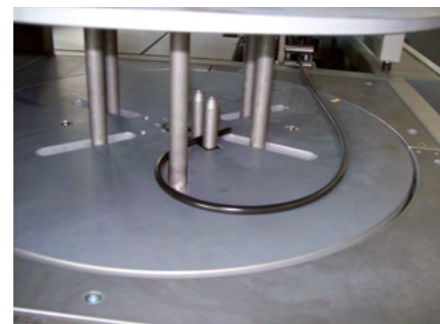

Fig. 4 Cable fixing clamp for winding plate

RINGROL 600

- Semi-automatic coil winding machine for coil-Ø max. 600 mm

Functionality:

This semi-automatic coil winder allows to wind materials such as cables, tubes etc. onto coils. Simultaneously, the material can be measured and cut to length. The mounted extension unit with automatic traversing drive is provided for the installation of a length measuring device (additional equipment), a material cutter or a feeder unit. The machine works semi-automatically, the cable catch is manually fed into the winding core. The machine winds the coil automatically and stops upon reaching the pre-selected length. Afterwards, the wound coil is pushed to the desk of a binding device (accessories) by the operator in order to be wound finally. Kabelmat drum storage racks are suitable for the direct winding.

Technical data	RINGROL 600
Part No.	3830.000
Winding material-Ø (depending on material)	max. 20 mm
Winding plate-Ø	600 mm
Core-Ø	200 - 370 mm infinitely variable
Winding height	50 - 160 mm infinitely variable
Operating height	1075 mm (+/- 25 mm)
Coil weight	max. 25 kg
Rotation speed	0 - 280 min ⁻¹ (1,5 kW) continuously adjustable
Line speed	max. 200 m/min
Electrical connection (CEE-connector plug)	230 / 400 V - 50 Hz
L x W x H (without binding unit and closed protective cover)	approx. 2200 x 1350 x 1650 mm
Weight	approx. 600 kg

Basic equipment:

- Painted, solid steel profile frame with two lockable steering rollers and two fixed rollers
- Protective hood with safety switch integrated in the machine
- Horizontal table board equipped with integrated winding plate and core segments which can be lowered
- Winding core pneumatically adjustable
- Winding core diameter continuously adjustable manual, with scale
- Automatic tapering of the core when lowering
- Ring height adjustable by a motor
- Pneumatic free lift of the winding counter plate
- Traversing slide prepared for the assembly of additional devices such as length measuring devices, material cutter, feeding systems and guides
- Automatically driven traversing slide consisting of geared motor with working speed control
- Traversing speed automatically adapts to the winding working speed (synchronization)
- Winding drive by AC-geared motor with variable working speed allowing a smooth start
- Speed control adjustable via potentiometer in the control panel
- Electrical switch cabinet installed in the machine
- Operating panel ergonomically integrated into the base frame
- Operating side: on the left (in winding direction)
- Easy-to-handle control and operating centre in the working area with emergency-stop button, provided for the installation of a pre-selection counter
- Touchpanel for the display of operating conditions and error messages as well as for the input of operating parameters

Recommended equipment:

- **Length measuring device MESSBOI 40 LC / LC-MID** with optionally selectable central adjustment of the guide rollers
 - Error limit (with in-and outlet roller cages) +/- 0,5 %
 - Conformity assessment of the length measuring device according module F is approved by German calibration authority for a period of two years, valid in EEA.
 - Pre-selection counter with disconnecting contact of the drive

Optional:

- **Automatic storage** of the cutting data
- **Pneumatically operated cutting** unit for cutting the winding material
- **Material feeder** allows to put the winding material quickly in the winding unit
- **INKJET printer** in order to print phrases or figures onto the winding material
- **Binding unit** for wound coil mountable at the machine



Fig. 5 Binding unit

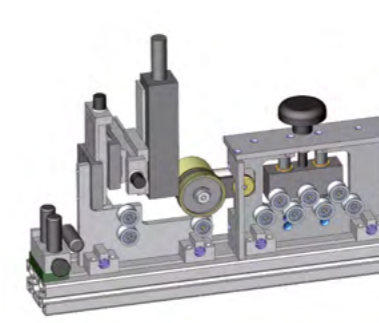

Fig. 6 Guiding unit for the printing head

Recommended delivery systems:

- Unwinder: TROMTRAK, TROMROL, UMRÖL or PORTROL as feeding system manually driven or motorized
- Drum storage and unwinding system LAGROL

Further auxiliary equipment on request

RINGROL 800

Semi-automatic coil winder

Coil winding made easy



Fig 1 RINGROL 800



Fig 2 Example traversing unit

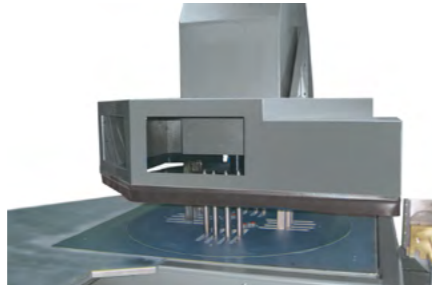

Fig 3 Winding unit

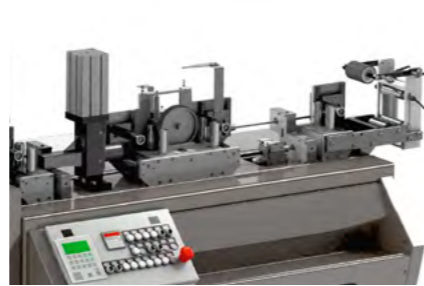

Fig. 4 Central adjustment of the guide rollers optional motor driven version available

RINGROL 800

- Semi-automatic coil winding machine for coil-Ø max. 800 mm

Functionality:

This semi-automatic coil winder allows to wind materials such as cables, tubes etc. onto coils. Simultaneously, the material can be measured and cut to length. The mounted extension unit with automatic traversing drive is provided for the installation of a length measuring device (additional equipment), a material cutter or a feeder unit. The machine works semi-automatically, the cable catch is manually fed into the winding core. The machine winds the coil automatically and stops upon reaching the pre-selected length. Afterwards, the wound coil is pushed to the desk of a binding device (accessories) by the operator in order to be wound finally. Kabelmat drum storage racks are suitable for the direct winding.

Technical data	RINGROL 800
Part No.	3853.000
Winding material-Ø (depending on material)	max. 30 mm
Winding plate-Ø	800 mm
Core-Ø	300 - 550 mm infinitely variable
Winding height	50 - 200 mm infinitely variable
Operating height	1075 mm (+/- 25 mm)
Coil weight	max. 70 kg
Rotation speed	0 - 250 min ⁻¹ (3 kW) continuously adjustable
Line speed	max. 250 m / min
Electrical connection (CEE-connector plug)	230 / 400 V - 50 Hz
L x W x H	2700 x 1700 x 2100 mm
Weight (without accessories)	approx. 800 kg

RINGROL 800

Semi-automatic coil winder

Basic equipment:

- Painted, solid steel profile frame to be screwed on the ground
- Protective hood is pneumatically opened and closed at a push of a button
- Protective hood with safety switch integrated in the machine
- Horizontal winding desk with built-in winding plate
- Winding core pneumatically adjustable
- Infinitely variable core diameter
- Counter plate adjustable to coil width by push of a button
- Pneumatically liftable counter plate
- Traversing slide provided for additional units such as length measuring devices, material cutter, feeders and guidances
- Automatic servo drive for traversing slides
- Traversing speed automatically adapts to rotation speed (synchronization)
- Winding drive by AC gear motor with infinitely variable speed control as well as speed control via potentiometer adjustable in control desk
- Easy-to-handle control and operating centre in the working area with emergency-stop button, provided for the installation of a pre-selection counter
- Touch panel for the display of operating conditions and error messages as well as for the input of operating parameters
- Electrical switch cabinet installed in the machine
- Electrical connection via strip terminal in switch cabinet
- Operating side: on the left (in winding direction)

Recommended equipment:

- **Length measuring device MESSBOI 80 LC / LC-MID** with optionally selectable central adjustment of the guide rollers
 - Error limit, accuracy class III with additional inlet and outlet roller cages + / - 0,5 %
 - Conformity assessment of the length measuring device according module F is approved by German calibration authorities for a period of two years, valid in EEA
 - Pre-selection counter with disconnecting contact of the drive

Optional:

- **Automatic storage** of the cutting data
- **Pneumatically operated cutting unit** for cutting the winding material
- **Material feeder** allows to put the winding material quickly in the winding unit
- **INKJET printer** in order to print phrases or figures onto the winding material
- **Binding unit** for wound coil mountable at the machine

Further auxiliary equipment on request

RINGROL 1200

Fully automatic coil winder

High outputs,
Short changeover times -
Fully automated coil winding



Fig. 1 RINGROL 1200 with safety fence and roller guide

RINGROL 1200

- Fully automatic coil winder for coil-Ø max. 1200 mm

Functionality:

This horizontally working fully automatic coil winder has been designed for winding in-line and off-line plastic pipes (e.g. B. PE, PE-X, PB, etc.), plastic metal compound pipes (e.g. B. PE-AL-PE, PE-CU, etc.) as well as hoses and other coilable materials. The pipe to be coiled is at first transported by means of the feed unit (either provided for by the customer or integrated in the laying unit). The material feed (roller guide or guiding pipe) transports the front end of the pipe to the opening provided for in the winding core and there, it is pneumatically fixed. This operation takes place without stop up to extrusion speed due to the synchronisation of the servo-controlled axles so that there is no need to stop the continuously extruded pipe. Due to the rotational movement of the winding core, a coiled pipe bundle is obtained. Prior to cutting, the bundle is held together by a four-arm gripper. After winding the remaining length, the winding core is with drawn upwards and the bundle is transported to the strapping unit. The coil can be strapped several times with PP strap or wrapped with plastic foil. For this purpose, it is turned over. On completion of the strapping, the coil is pushed out on a roller track by means of a two-axle coil ejector. Sturdy machine frame with sheet-metal covecoil of stationary design with a separately placed electric switch cabinet and switch desk for the central control of all machine functions.

Technical Data	RINGROL 1200
Part No.	3021.000
Winding material-Ø	8 - 32 mm
Coil outside-Ø	580 - 1200 mm
Winding core-Ø	400 - 600 mm
Winding height (coil width)	90 - 600 mm

RINGROL 1200

Fully automatic coil winder

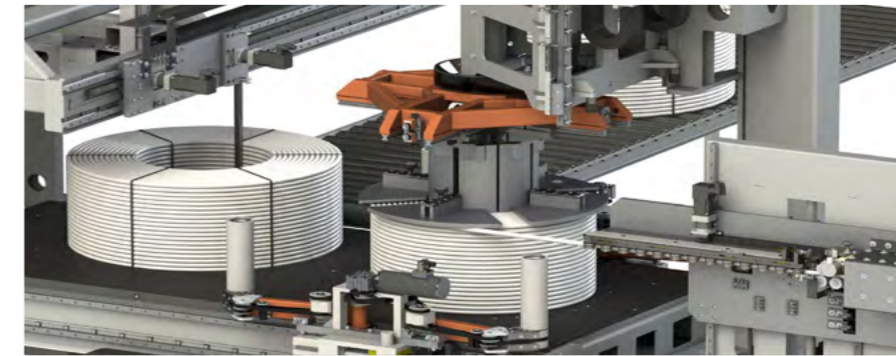

Fig. 2 Functional principle



Fig. 3 Finished product

Basic equipment:



Fig. 4 Traversing unit

Operator panel

- The operator panel is swivelling and installed at the operating side

Traversing unit

- Horizontally, vertically and longitudinally displaceable unit for the precise laying and positioning of the front end of the pipe at the winding core

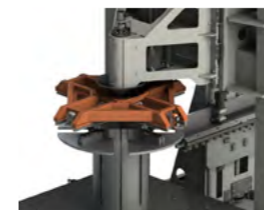

Fig. 5 Coil winding station

Coil winding station

- Horizontally working winding unit with hinged winding cores
- Winding height (coil width) and winding core diameter are steplessly adjustable

Coil gripper system

- Pneumatically operated double-sided gripping unit to hold down the coiled bundle of coils and to transport it to the strapping unit
- Rubber covered driven gripping rollers to turn the bundle of coils ducoil strapping

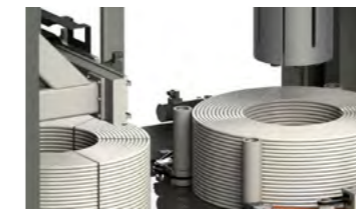

Fig. 6 Coil gripper system

Coil ejector

- Two-axle linear system driven by a servomotor for pushing out the finished bundle of coils onto a roller track



Fig. 7 Coil ejector



Fig. 9 Strapping station for PP straps

Strapping station for PP straps

- Station for the multiple strapping of the bundle of coils with PP strap trough the lug of the coil

Further modules:



Fig. 8 Wrapping station for stretch straps

Wrapping station for stretch straps (as an alternative to wrapping with PP straps)

- For the partial or complete wrapping of the bundle of coils trough the lug

Holding-down device for the wrapping station

- To avoid that the bundle of coils bursts prior to wrapping (particularly in case of rigid elastic plastic pipes)
- Automatically adjustable to changing height

Indoor use only.
Fig. may differ from original.
Technical modifications reserved.

UMROL 1000 AUF

Pintle winder for coils and drums

Winding big drums at the touch of a button



Fig. 1 UMROL 1000 AUF with closed cover

UMROL 1000 AUF

- Pintle winder for coils and drums

Functionality:

This motor driven coil and drum pintle winders are suitable for winding goods, such as cables, tubes, hoses, steel ropes, plastic profiles etc. onto coils, spools or drums and simultaneously, measuring and cutting-to-length.

The empty drum on which the material is to be coiled, is rolled to the loading place. The previously opened centre sleeve arms are then moved together to the corresponding take-over position by the operator's push of a button. When the drum is clamped by the centre sleeves, the same move upwards in winding position. On the operating panel the drum can be turned forward and backward in manual operation. Prior to winding in automatic mode, the length to be cut is input with the keyboard of the Kabelmat preselection counter LC MID. In automatic winding mode, the preselected length is coiled. The drive traces the length according to the potentiometer adjustment on the operating panel and stops automatically once the length is reached. Soft start and soft stop of the drive according to the programmed ramps. The additional inching function is adjusted once only in the preselection counter. When the coiled material is cut off and the end is fixed, the drum is lowered again by the push of a button, it is rolled out of the machine and removed.

Technical Data	UMROL 1000 AUF
Part No.	2025.000
Drum-Ø	400 - 1000 mm (DIN 46391)
Drum width	120 - 710 mm
Drum weight	max. 600 kg
Standard drives (special speed on request)	75 min ⁻¹ (2,2 kW) or 130 min ⁻¹ (4,0 kW)
Inlet height of winding material	approx. 1230 mm
Traversing width	approx. 700 mm
Running direction	right to left
L x W x H	approx. 2135 x 1770 x 2245 mm
Weight	approx. 1100 kg

Max. winding material-Ø depending on the characteristics of the winding material.

UMROL 1000 AUF

Pintle winder for coils and drums

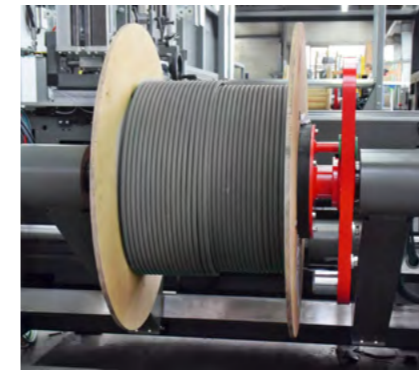

Fig. 2 Frictionally engaged drum driver



Fig. 3 UMROL 1000 AUF mobile with open cover



Fig. 4 UMROL 1000 AUF stationary with closed cover

Basic equipment:

- Steel profile frame with two breakable steering rollers and two fixed rollers or stationary design: to be screwed on the ground
- Grips for moving the machine
- Manually operated traversing slide provided for the installation of additional devices such as length measuring devices, material cutters as well as an automatic traversing unit
- Easy-to-handle and convenient drum loading with pintle arms driven by electric motor
- The functions lifting / lowering and tightening/releasing of the pintles are activated by push of a button
- Different cones for drum core drilling are insertable
- Holding fixture for coiler heads (quick-change system)
- The control panel with emergency switch is integrated in the base frame
- Additional control panel for positioning of the pintle arms, drum driver and emergency stop function
- Winding drive via geared motor with infinitely variable speed control and smooth starting of the machine
- Right-left handed rotation of the winding drive within the jogger operation mode
- Protective door for UMROL (available as collapsible door or as cover, requested for CE)

Recommended equipment:

- **Roller cages** before and after the length measuring device with adjustable ball beared rollers made of stainless steel requested for the calibration of the measuring devices
- **Length measuring device MESSBOI 40 LC / LC-MID or MESSBOI 80 LC / LC-MID**
 - Error limit, accuracy class III with additional inlet and outlet roller cages + / - 0,5 %
 - Conformity assessment of the length measuring device according module F is approved by German calibration authorities for a period of two years, valid in EEA
 - Conformity assessment line speed up to 250 m / min
 - Preselection counter with disconnecting contact of the winding drive
 - Diameter recognition
- **Manually, pneumatically or hydraulically operated cutting device** for cutting the winding material
- **Automatic traversing** consisting of geared motor with rotation speed controller. Traversing can be moved to any position via joystick within the set-up mode. This is important for the starting position of the winding drive. The motion reversing points can be stored by means of reference keys during standstill of the machine but also during winding operation. Traversing speed adapts automatically to the winding speed (synchronization). The complete traversing drive can be unlatched for manual traversing.
- **Coiler head incl. adapter** for coil winding. Insertable into the coiler head acceptance. Centrally and infinitely adjustable winding core diameter. With four binding slots and four winding core segments. Various models available.
- **Frictionally engaged drum driver** with sleeve for easy loading of the drum without carrier bolts. Consisting of two carriers for both pintle arms; cylindric drum loading

Further auxiliary equipment on request

UMROL 1400 / 1600 / 2200 AUF

Pintle winder for coils and drums

Winding big drums at the touch of a button

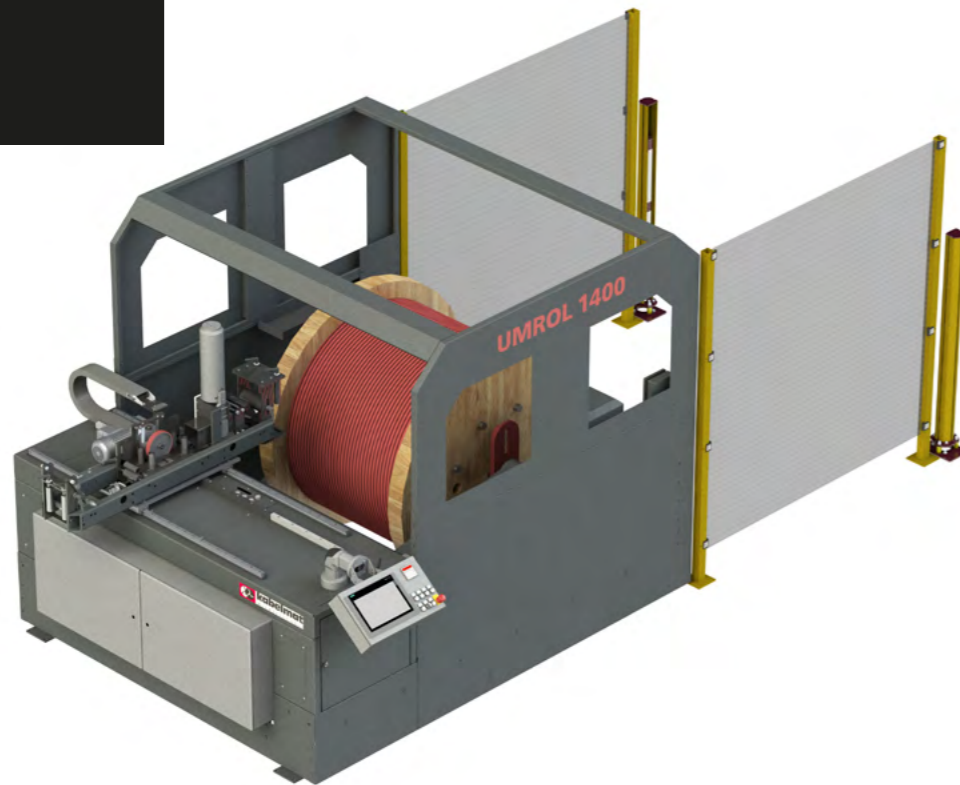

Fig. 1 UMROL 1400 AUF with protective fence

UMROL 1400 / 1600 / 2200 AUF

- Pintle winder for coils and drums

Functionality:

This motor driven pintle winder is suitable for winding goods, such as cables, hoses, steel ropes etc. onto coils or empty drums and, simultaneously, measuring and cutting them to length by making use of adequate accessories.

Upon opening the protective door the empty drum is rolled to the place of loading in order to be wound. By push of a button, the previously opened pintle arms are first moved together and then to the appropriate height for take-over. The pintles clamp the drum. Then the drums are lifted to winding position where they can be rotated forwards or backwards manually at the operating desk. Prior to the automatic winding of the material its cutting length is adjusted on the keyboard of the Kabelmat pre-selection counter LC MID. The pre-selected length is wound during automatic winding operation and the drive stops also automatically as soon as the requested length is reached. Smooth start and stop of the drive according to the adjusted ramps. Additional creep speed function in the pre-selection counter to be adjusted once. Upon cutting and fixing the end of the winding material, the ready wound drum is lowered by push of a button, rolled out of the machine and taken away.

Technical data	UMROL 1400 AUF	UMROL 1600 (1800) AUF	UMROL 2200 AUF
Part No.	2045.000	2050.000 (2055.000)	2075.000
Drum-Ø	630 - 1400 mm	630 - 1600 (710 - 1800) mm	710 - 2240 mm
Drum width	max. 900 mm	max. 1120 mm	max. 1450 mm
Drum weight	2000 kg	3000 kg	6000 kg
Traversing width	1090 mm	1200 mm	1700 mm
Winding drive	75 min ¹ or 130 min ¹	60 min ¹ or 110 min ¹	40 min ¹ or 60 min ¹
Engine power	4 or 7,5 kW	5,5 or 11kW	7,5 or 11 kW
L x W x H	approx. 3000 x 2290 x 2300 mm	approx. 3200 (3400) x 2360 x 2300 mm	approx. 3800 x 2950 x 2500 mm
Weight	approx. 2500 kg	approx. 2800 kg	approx. 4800 kg

Drum sizes as per DIN 46391/46395 and KTG - All sizes are non-binding and will be defined in case of order. Max. winding material-Ø depending on the characteristics of the winding material.

UMROL 1400 / 1600 / 2200 AUF

Pintle winder for coils and drums

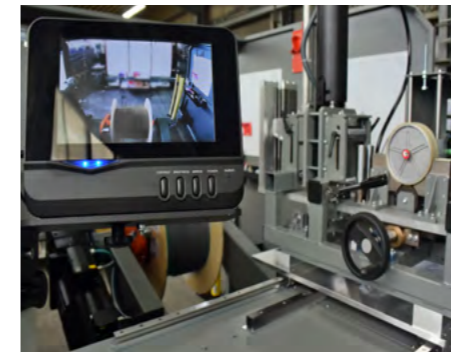

Fig. 2 Traversing camera

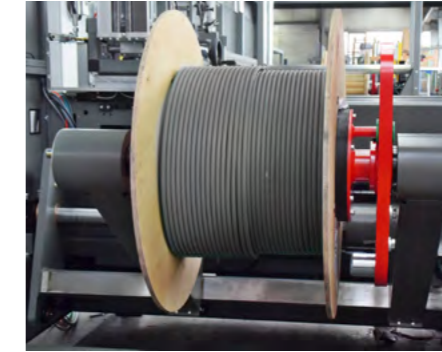

Fig. 3 Frictionally engaged drum driver



Fig. 4 Drive unit with drawbar

Basic equipment:

- Steel profile frame with two breakable steering rollers and two fixed rollers or stationary design to anchor to the floor
- Grips for moving the machine
- Manually operated traversing slide provided for the installation of additional devices such as length measuring devices, material cutters as well as an automatic traversing unit
- Easy-to-handle and convenient drum loading with hydraulically operated pintle arms
- The functions lifting/lowering and tightening/releasing of the pintles are activated by push of a button
- Holding fixture for coiler heads (quick-change system)
- Easily operatable control desk with emergency switch, provided for the installation of a length measuring unit
- Additional control panel for operation of the hydraulic functions, the positioning of the pintle arms and emergency stop function
- Winding drive: working speed and power selectable
- Right-left handed rotation of the winding drive within the jogger operation mode
- Protective door for UMROL (available as collapsible door or as cover, requested for CE)

Recommended equipment:

- **Roller cages** in front of and after the length measuring device with adjustable ball beared rollers of stainless steel. These are necessary for the calibration of the measuring devices.
- **Length measuring device MESSBOI 80 LC / LC-MID or MESSBOI 100 LC / LC-MID**
 - Error limit, accuracy class III with additional inlet and outlet roller cages + / - 0,5 %
 - Conformity assessment of the length measuring device according module F is approved by German calibration authorities for a period of two years, valid in EEA
 - Conformity assessment line speed up to 250 m / min for MESSBOI 80 LC / LC-MID, 150 m / min for MESSBOI 100 LC / LC-MID
 - Preselection counter with disconnecting contact of the winding drive
 - Diameter recognition
- **Hydraulically operated cutting device** for cutting the winding material
- **Automatic traversing** consisting of geared motor with rotation speed controller. Traversing can be moved to any position via joystick within the set-up mode. This is important for the starting position of the winding drive. The motion reversing points can be stored by means of reference keys during standstill of the machine but also during winding operation. The traversing grade is continuously adjustable via rotary potentiometer even during winding operation. The traversing speed adapts automatically to the winding speed (synchronization). The complete traversing drive can be unlatched for manual traversing.
- **Coiler head incl. adapter** for coil winding. Insertable into the coiler head acceptance. Centrally and infinitely adjustable winding core diameter. With four binding slots and four winding core segments. Various models available.
- **Frictionally engaged drum driver** with sleeve for easy loading of the drum without carrier bolts. Consisting of two carriers for both pintle arms; cylindric drum loading.
- **Travelling drive** for mobile use

Further auxiliary equipment on request

UMROL 1400 / 1600 / 2200 AUF

Pintle winder for coils and drums

High level of security and defined working areas



Fig. 5 UMROL 1400 AUF with flap gate



Fig. 6 UMROL 2200 with protective fence and coiler head, view 1

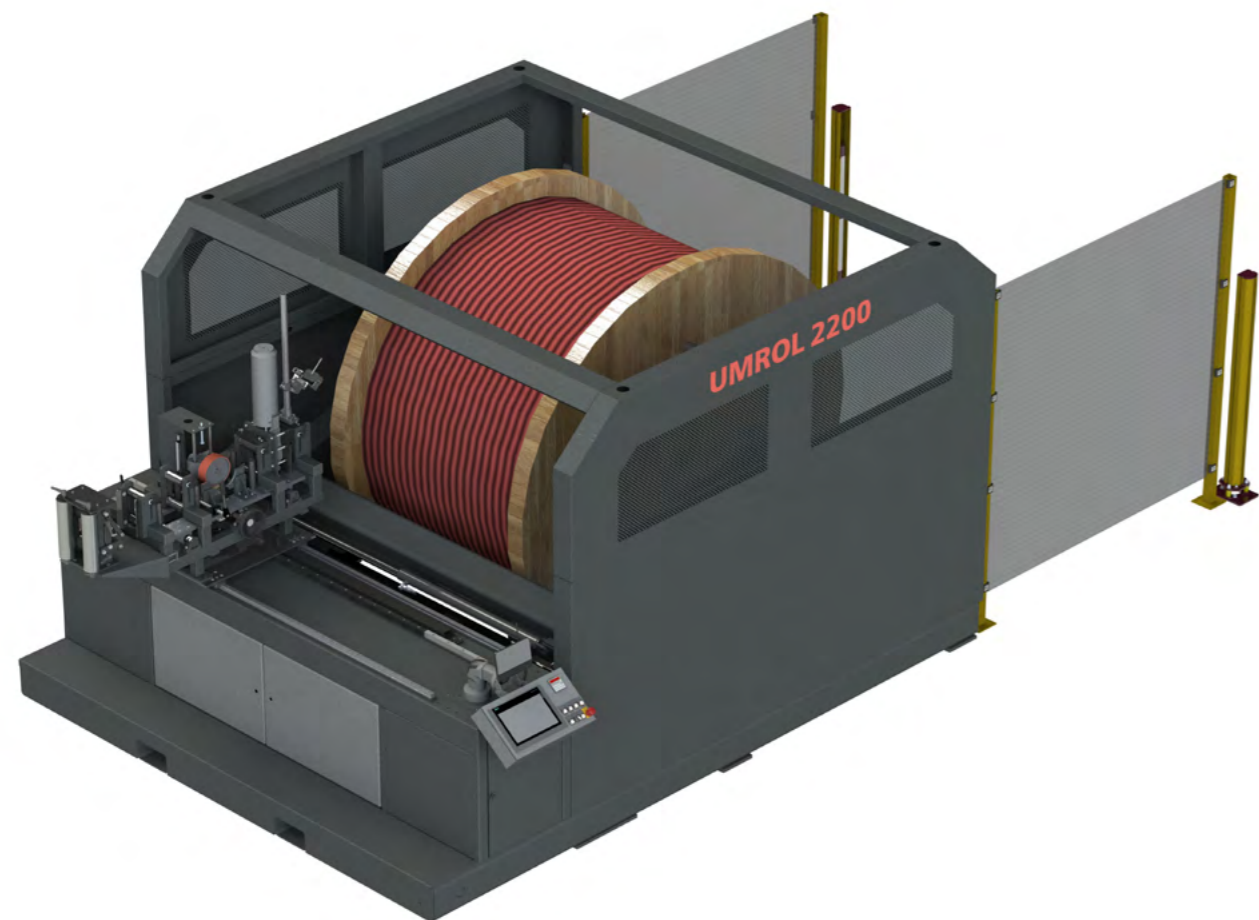

Fig. 7 UMROL 2200 with protective fence, view 2

PORTROL 1000 / 1400 AUF

Pintle winder for coils and drums

Cut at the touch of a button

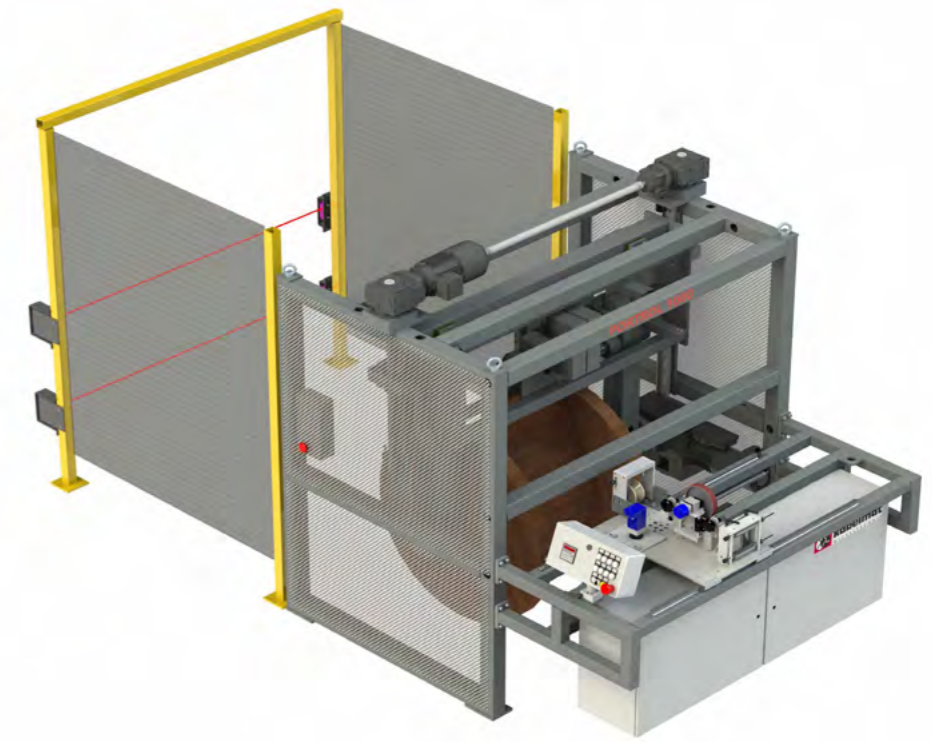

Fig. 1 PORTROL 1000 AUF

PORTROL 1000 / 1400 AUF

- Pintle winder for drums and coils

Functionality:

This motor driven pintle winder is suitable for winding goods, such as cables, hoses, steel ropes etc. onto coils or empty drums and, simultaneously, measuring and cutting them to length by making use of adequate accessories.

Upon opening the protective door the empty drum is rolled to the place of loading in order to be wound. By push of a button, the previously opened pintle arms are first moved together and then to the appropriate height for take-over. The pintles clamp the drum. Then the drums are lifted to winding position where they can be rotated forwards or backwards manually at the operating desk. Prior to the automatic winding of the material its cutting length is adjusted on the keyboard of the Kabelmat pre-selection counter LC MID. The pre-selected length is wound during automatic winding operation and the drive stops also automatically as soon as the requested length is reached. Smooth start and stop of the drive according to the adjusted ramps. Additional creep speed function in the pre-selection counter to be adjusted once. Upon cutting and fixing the end of the winding material, the ready wound drum is lowered by push of a button, rolled out of the machine and taken away.

Technical data	PORTROL 1000 AUF	PORTROL 1400 AUF
Part No.	6198.000	6251.000
Drum-Ø	400 - 1000 mm	400 - 1400 mm
Distance between the cones	max. 780 mm	max. 1050 mm
Drum weight	max. 900 kg	max. 2000 kg
Winding speed	max. 120 min ⁻¹	max. 120 min ⁻¹
Traversing width	approx. 700 mm	approx. 1050 mm
Inlet height of winding material	approx. 1030 mm	approx. 1130 mm
L x W x H	1530 x 2200 x 2100 mm	2300 x 2400 x 2500 mm
Colour housing	RAL 7005 mouse grey	RAL 7005 mouse grey
Weight	approx. 1200 kg	approx. 1400 kg

Max. winding material-Ø depending on the characteristics of the winding material.

PORTROL 1000 / 1400 AUF

Pintle winder for coils and drums

Basic equipment:

- Solid steel profile frame to be screwed on the floor
- Manually operated laying slide, prepared to accommodate additional equipment such as length measuring devices, material cutters as well as an automatic laying device
- Very simple and easy material holding fixture with electric motor operated centre sleeve arms
- The functions lifting / lowering as well as clamping / opening of the centre sleeves at the push of a button
- Various slip-on cones for the borehole of the drum core
- Control panel with emergency stop button is ergonomically integrated in the base frame
- Additional control panel for operating the traversing functions and positioning the quill arms, as well as emergency stop function in the reel-in area of the drum
- CE conformity declaration according to machinery directive 2006 / 42 / EG
- Switch cabinet integrated in the machine frame
 - Main Switch
 - Speed regulation steplessly adjustable with soft starting and soft running
- Right to left running of the winding drive in inching operation
- **Roller cages** before and behind the length measuring unit, easily adjustable to match the material.
Various models available depending on the requirements
- **Length measuring device MESSBOI 40 LC / LC-MID, MESSBOI 40 B LC / LC-MID or MESSBOI 80 LC / LC-MID**
 - Error limit, accuracy class III with additional inlet and outlet roller cages + / - 0,5 %
 - Pre-selection counter with disconnecting contact of the drive

Recommended equipment:

- **Automatic traversing** consisting of gear motor with speed controller. Traversing can be moved to any position via joystick. This is important for the starting position of the winding drive. The motion reversing points can be stored via reference keys during machine downtime but also during winding operation. In usage of round winding materials the traversing pitch adapts automatically via diameter detection, but is also adjustable via rotary potentiometer during the winding operation. In case of winding flat material there is no diameter detection function. The traversing pitch has to be adjusted continuously via rotary potentiometer during the winding operation. The traversing speed automatically adapts to the winding speed (synchronization). The complete traversing drive can be disengaged for manual traversing.
- **Pneumatic or hydraulic operated cutting system** for cutting the winding material
- **Roller feed** in support of cutting process and in connection with pneumatic cutting device for additional operation mode "Cut to length without winding process"
- **Coiler head** for winding of coils.
Various models available
- **Conformity assessment / MID (formerly first calibration)**
 - **Automatic storage** of the cutting data
 - **Label printer** with interface to the preselection counter
 - **Conformity assessment** to module F (in accordance with the European Measuring Instruments Directive 2014/32/EU) of the length measuring device with additional inlet and outlet roller cages by the German calibration authority. **Valid for a period of two years** for all member states of the EEA. The assessment is carried out in the manufacturer's factory. **Calibration after two years is required**, but is not included in the scope of delivery. Note: Conformity assessment according to module F (formerly first calibration) is required when the **customer is not present** during the cutting of the material (cables ect.). **Required:** Storage of the cutting data and documentation on the business records.

Further auxiliary equipment on request

PORTROL 1000 / 1400 ABW

Pintle unwinder for drums

Drum unwinder with material accumulator

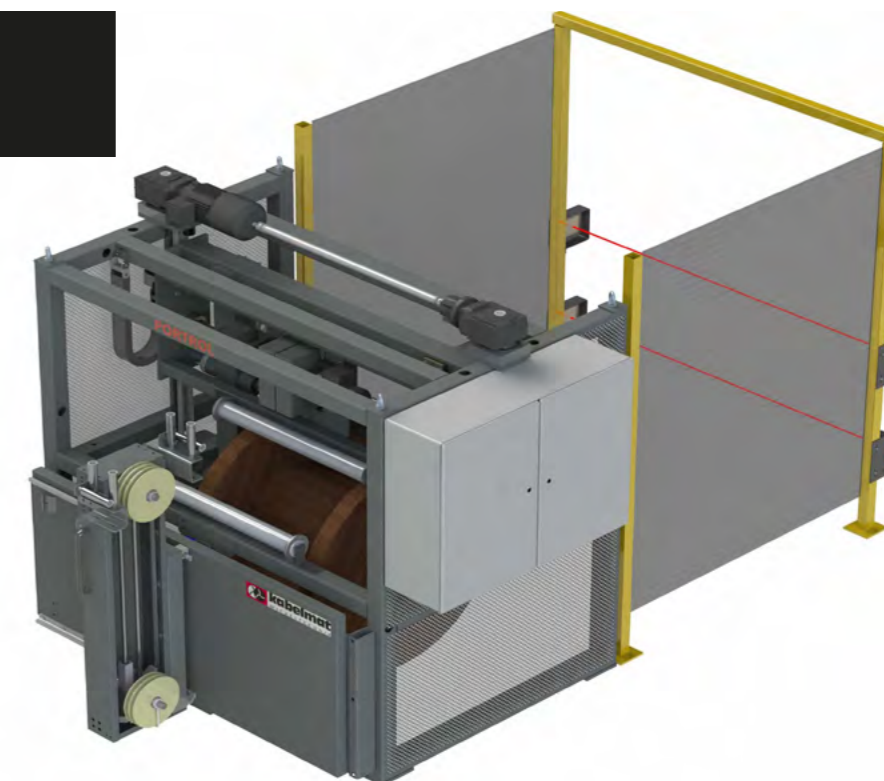

Fig. 1 PORTROL 1000 AB

PORTROL 1000 / 1400 ABW

- **Pintle unwinder for drums**

Functionality:

This portal-type winder is suitable as individual machine or can be used in complete processing lines. The drum attachment is time-saving and safe due to spindle sleeves. The drum is rolled to the loading place. The previously opened centre sleeve arms are then moved together to the corresponding take-over position by the operator's push of a button. When the drum is clamped by the centre sleeves the same move upwards in winding position. On the operating panel the drum can be turned forward and backward in manual operation. When operating in a line, the unwinder (Pay-off) is then automatically controlled. A prerequisite for this is that there is no person or object in the access area of the safety light barriers. The speed is controlled by a dancer roller or a material buffer ACUMATIC as well as optionally by the additional preset nominal value. This takes into account the corresponding high time or elapsed time resp. as well as the line speed. This ACUMATIC is available in different types and sizes. It controls the speed of an unwinder according to the start and brake cycles and serves also as bridgeover of short standstill periods of a winding line. The ACUMATIC is particularly required for tension-sensitive materials. However, tension-sensitive materials can also be coiled directly using the additional operating mode "closed-loop torque control".

Technical data	PORTROL 1000 ABW	PORTROL 1400 ABW
Part No.	6197.000	6250.000
Drum-Ø	400 - 1000 mm	400 - 1400 mm
Distance between centres with cones	max. 750 mm	max. 1050 mm
Drum weight	max. 900 kg	max. 2000 kg
Winding drive	max. 120 min ¹	max. 120 min ¹
L x W x H	1530 x 2200 x 2100 mm	1860 x 2420 x 2500 mm
Weight	approx. 900 kg	approx. 1200 kg
Max. winding material-Ø depending on the characteristics of the winding material.		

PORTROL 1000 / 1400 ABW

Pintle unwinder for drums

Basic equipment:

- Solid steel profile frame to be screwed on the floor
- Drum carried by pintles with easily exchangeable cones incl. on one-side mounted impeller and movable carrier bolts
- Easy-to-handle and convenient drum loading with pintle arms driven by electric motor
- The pintles move together and allow the use of very narrow spools
- The functions lifting / lowering and tightening / releasing of the pintle arms are activated by push of a button
- The control panel for loading of the winders is installed in the drum roll-in area (on motor side)
- Switch cabinet implemented in the machine
- Electrical connection via CEE coupler plug at the switch cabinet
- Operator's stand on the left side of the machine (pass-through direction of the winding material), optionally on the right side
- safety equipment required for CE (selectable systems)
 - Protection door for PORTROL (foldable design)
 - Safety fence with two super-imposed safety light barriers

Recommended equipment:

- **Speed-controlled gear motor** depending on technical specifications
- **Frictionally engaged drum driver** with sleeve for easy loading of the drum without carrier bolts. Consisting of two carriers for both pintle arms. Cylindric drum loading.
- **ACUMATIC, material accumulator / dancer**
- **Instantaneous regulation of winding drive**

TROMPIN 800 / 1250

Drum and spool unwinder

With mounted accumulator

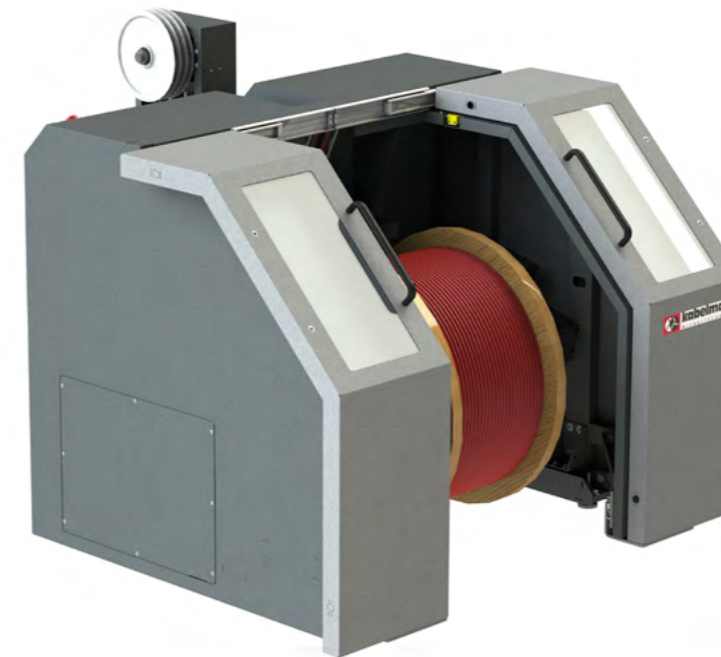

Fig. 1 TROMPIN 800 with open safety doors



Fig. 2 TROMPIN 800 back view with mounted accumulator section



Fig. 3 TROMPIN 800 with closed safety doors

TROMPIN 800 / 1250

- **Motorised drum and spool unwinder for cables, hoses and other materials**

This motorised drum and coil unwinder is the perfect addition to our range of stripping and winding machines. The fitted accumulator section allows you to unwind cables, hoses and much more virtually free of tension and enables synchronisation of the drive units along the line of machines (consisting of stripping, winding and pay-off devices).

Functionality:

The drum that is to be unwound is rolled to the mounting location by hand. The drum is mounted securely and expeditiously using barrel arms. The operator presses a button to move the open barrel arms together one by one and to the correct transfer height. Once the barrel arms have clamped the drums in place, they are moved up to the unwinding position. The unwinder is controlled automatically in a line operation. This can only take place if the safety doors are closed.

Technical data	TROMPIN 800	TROMPIN 1250
Part No.	2035.000	2037.000
Drum-Ø	400 - 800 mm	400 - 1250 mm
Drum weight	max. 400 kg	max. 600 kg
Material-Ø	approx. 1 - 16 mm	approx. 1 - 16 mm
Distance between centre of cones	max. 660 mm	max. 1050 mm
Speed for core-Ø > 200 mm*	180 m / min	180 m / min
Accumulator section wheel-Ø	240 mm	240 mm
L x W x H	approx. 1750 x 1500 x 1500 mm	approx. 2200 x 2200 x 1700 mm
Weight	approx. 750 kg	approx. 1250 kg

Storage section wheel assembly and tensile force subject to customer specification.
 * For a core-Ø < 200 mm, the max. speed will decrease

SPULFIX 480

Coil and spool unwinding machine

Perfect complement
to processing machines



Fig. 1 SPULFIX 480 with open cover

SPULFIX 480

- Coil and spool unwinding machine

Functionality:

This machine is used as feeding device of all kinds of winding material to processing machines, such as Kabelmat take-ups or pre-assembling systems, e.g. automatic cutting machines, dismantling or stripping devices. The winding good can optionally be understood as coil or spool material. The rotation speed of the unwinder is controlled either by an accumulator or alternatively by additional set value taking the requested run-up and run-down time as well as the line speed into consideration.

Technical data	SPULFIX 480
Part No.	1823.000
Unwinding plate-Ø	max. 480 mm
Loading capacity	max. 20 kg
Accumulator capacity	3 m
Numbers of accumulator wheels	5 / 6
Winding material-Ø	max. 10 mm
Unwinding rotation speed	200 U / min
Pull force without additional weight	1,0 N
Pull force with weight (abt. 200 g)	1,5 N
Pull force with 2 weight (abt. 650 g)	1,7 N
Pull force with 3 weight (abt. 850 g)	2,0 N
L x W x H	approx. 1350 x 620 x 1860 mm
Weight	approx. 120 kg

SPULFIX 480

Coil and spool unwinding machine

Basic equipment:

- Mobile basic machine as self-supporting, torsionally resistant weldment
- Holder for exchangeable dispensing plate of an outer diameter of up to 480 mm
- Mounted accumulator with a stroke of 500 mm and reverse-locked outlet roller
- Switch cabinet with operating elements
- Additional outlet dancer for decreasing the starting pull force
- Built-in potentiometer for pre-setting the line speed
- Switch-off sensor for lower and upper accumulator position
- Sensor for regulating the dispensing plate

Additional equipment:

- SPULFIX 480 horizontal unwinding plate for spools

Technical data

Spool-Ø	max. 470 mm
Spool width	max. 250 mm
Plate-Ø	480 mm
Core pin	Ø 16 x 200 mm
Centering cone for bore-Ø	25 - 80 mm
Spool weight	max. 20 kg
Colour	zinc-plated

- RINGFIX 480 horizontal unwinding plate for coils

Technical data

Coil outer-Ø	max. 470 mm
Plate-Ø	480 mm
Height centering cones (3 pcs.)	250 mm
Core adjusting range	140 - 320 mm
Coil weight	max. 20 kg
Colour	zinc-plated



Fig. 2 SPULFIX 480 unwinding plate



Fig. 3 RINGFIX 480 unwinding plate



Fig. 4 SPULFIX 480 with closed cover

Indoor use only.
Fig. may differ from original.
Technical modifications reserved.

TROMTRAK 1600

Axle unwinder for drums

Perfect complement to processing machines



Fig.1 TROMTRAK 1600 elektrohydraulic drum unwinder

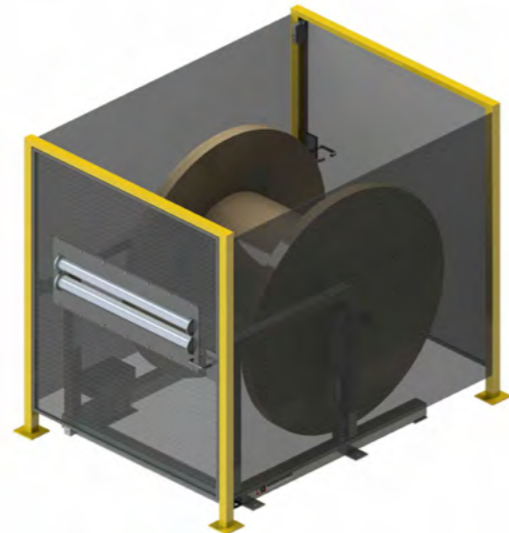

Fig.2 TROMTRAK 1600 with safety fence with wing doors as access to the drum loading with safety shutdown and outlet roller cage for guiding the winding material

TROMTRAK 1600

- Electrohydraulic unwinder for drums max. 3000 kg

Functionality:

TROMTRAK drum unwinder can be used as single unwinder as well as in complete processing lines. If the TROMTRAK 1600 unwinder is to be operated in conjunction with a motor-driven winder, a safety fence (Fig.2 or Fig.3) is absolutely necessary.

Basic equipment:

- Stationary frame
- Elektrohydraulic pump with manual release
- Two axles for the take-up of drum
- Two cones for centering the drums on the axle
- Electrical supply via CEE plug

Accessory for mechanical unwinding:

- **Safety fence for TROMTRAK 1600 with wing doors** as access to the drum loading with safety shutdown. Outlet roller cage for guiding the winding material.
- **Safety fence for TROMTRAK 1600 with wing and sliding doors** as access to the drum loading and the cable loading between the unwinder (Pay-off) and rewinder (Take-up) with safety shutdown.

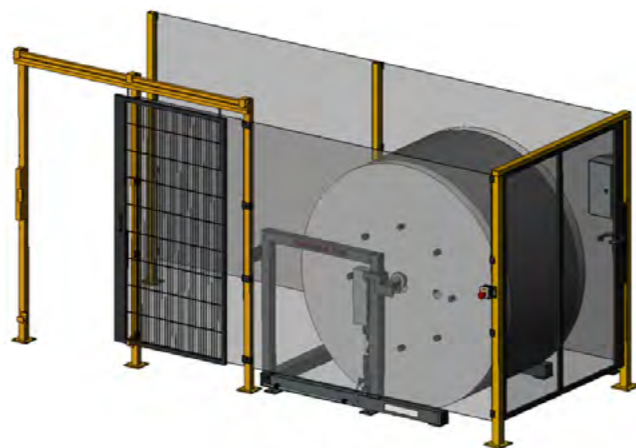

Fig.3 TROMTRAK 1600 with safety fence with wing and sliding doors as access to the drum loading and cable loading between unwinder and rewinder and rewinder with safety shut-off

Technical data	TROMTRAK 1600
Part No.	1189.000
Drum-Ø	500 - 1600 mm
Drum width	max. 1120 mm
Drum weight	max. 3000 kg
L x W x H	approx. 1600 x 1785 x 1200 mm
Weight	approx. 400 kg
Drum axle no. 1	Ø 34 x 1340 mm
Drum axle no. 2	Ø 60 x 1340 mm
Electrical supply via CEE plug	230 / 400 V - 50 Hz

TROMROL 2500

Axle unwinder for drums

Perfect complement to processing machines



Fig.1 TROMROL 2500

TROMROL 2500

- Electrohydraulic unwinder with axle and disk brake for drums up to 5000 kg

Functionality:

The range of application of this drum unwinder is the feed of coilable materials of all kind. It can be used as individual feeding equipment as well as in complete processing lines. The drum is fixed on an end-to-end axle.

Basic equipment:

- Frame of steel profiles with two rollers for heavy loads and two lockable steering rollers
- Drum holding fixture height adjustable by the push of a button by means of a hydraulic cylinder and an electrohydraulic pump

Accessory for mechanical unwinding:

- **Safety fence for TROMROL 2500 with wing doors** as access to the drum loading with safety shutdown. Outlet roller cage for guiding the winding material.

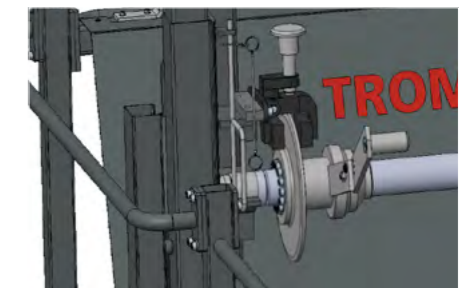

Fig.2 Disk brake and caliper

Technical data	TROMROL 2500	
Part No.	1182.000	
Drum-Ø	400 - 2500 mm	
Drum width	max. 1450 mm	
Drum weight	max. 5000 kg	
L x W x H	approx. 1750 x 2130 x 1900 mm	
Weight	approx. 500 kg	
Electrical supply via CEE plug	230 / 400 V - 50 Hz	

Accessory for TROMROL 2500	Drum axle up to 1200 kg	Drum axle up to 5000 kg
Axle-Ø	65 mm	70 mm
Axle loading	max. 1200 kg	max. 5000 kg
Weight	approx. 25 kg	approx. 38 kg
Material	aluminium	hot-dip zinc-plated

These axles are equipped with plain bearing. Disk brake with caliper. Brake force is adjustable by star grip.

SIGNOMAT

Sinter machine



Fig. 1 SIGNOMAT view 1

Permanent label print
on cables and wires

SIGNOMAT

- Sinter machine for cables and wires

Whether used nearby railways, in telecommunications, or power supply, cables almost always run underground. When they are dug out years later for service or maintenance work engineers want to easily identify what cable they are handling. In order to permanently identify the label, the SIGNOMAT prints on the cables and wires during production while they are still warm. This enables the machine to sinter the label.

Functionality:

This system allows highly resistant cable printing without affecting the mechanical or electrical properties of the material. The marking is visible, palpable and absolutely abrasion proof, what is useful e. g. in shafts where bad lighting conditions are prevailing; the form of the signs can be felt thanks to the surface roughness of the used sinter powder. The resistance to abrasion, weather conditions, humidity and aggressive soil gives the Signomat printer undoubtedly advantages opposite the ink jet printing system.

Unique process:

The marking is performed directly on the hot plastics, i. e. just after extrusion. Two marking wheels put the synthetic powder onto the extruded material at the distance requested and in compliance with the forms required. The sinter powder unites tightly with the surface of the extruded material. No additional heating is needed since the residual heat of the plastic material is used to melt powder and sheath (between 150° and 180°C).

SIGNOMAT

Sinter machine



Fig. 2 SIGNOMAT view 2



Fig. 3 SIGNOMAT centering device

Technical data	SIGNOMAT
Part No.	8501.000
Production speed	3 - 100 m / min
Range of Ø to be marked	6 - 100 mm
Circumference of marking wheel	1000 mm
Circumference of guiding wheel	1000 mm
Metering distance	1000 mm
Working height	950 - 1200 mm
Precision	< 1%
Marking powder consumption	approx. 250 g / km
Connected load	230 / 400 V
Connection power	approx. 1,0 kW
Line frequency	50 Hz
Electrical connection (CEE-connector plug)	CEE 16 A
Compressed air: Pressure	6 bar
Compressed air connection (quick release)	1 / 2 Zoll
L x W x H	approx. 800 x 800 x 1300 mm
Weight	approx. 300 kg
Colour	RAL 7005 mouse grey

Indoor use only.
Fig. may differ from original.
Technical modifications reserved.

MACHINERY PLANTS AND LINES



PRODUCTS

- AUTOLOG 82
- PORTROL 86

Powerful all-in-one solution

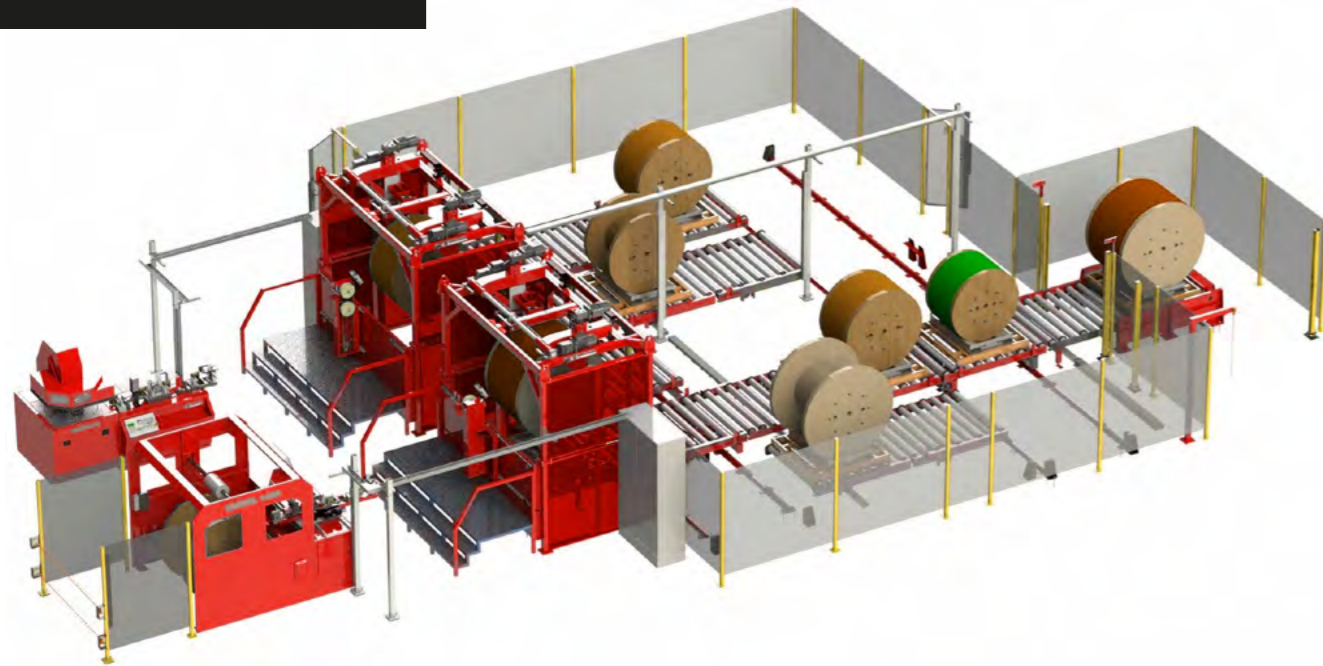

Fig. 1 AUTOLOG winding line

AUTOLOG

- Winding line with automatic drum pick-up

Cables and lines for the transfer of different types of electrical energy or data are now an important component of building services engineering, machine and plant engineering, telecommunications and a range of other applications.

Kabelmat offers two different systems which are described below:

System 1: Machine to drum

The approved system „Machine to drum“ is still used in many sectors. The advantages of this system are short access times by picking the material, easy operating of the machine as well a low investment costs. It is mainly used, where number of cuts are low and fewer additional staff will be needed.

System 2: Drum to machine

Depending on increasing centralisation of cable warehouses there is an continuously increasing number of variety of storing positions and cuttings. Routes to the machine are getting longer, complex and unprofitable. Therefore, more and more companies deciding to use the professional solution „Drum to machine“. To ensure an effiecent deployment of staff, it is recommended to automate procedures as far as possible. Kabelmat also offers the right support for this.

PERFECT INTERACTION

Synchronised workflow = reduced cycle time

WINDER AND UNWINDER

- High output performance
- High winding speed
- Automatic measurement of the drum
- Optical drum bore detection
- Automatic drum pick-up
- Frictionally engaged drum pick-up (no driver hole required)
- Winding drive on both sides for an even distribution of force on the drum
- Winding diameter registration for fine-tuning of the winding drives
- Cable accumulator for tension-sensitive cables

LENGTH MEASUREMENT

- Barcode identification of winding goods
- Assignment and documentation of winding goods
- Automatic storage and retrieval of winding data
- Marking of winding material by label printer (date, material, length, company logo)

SAFETY TECHNOLOGY

- Closed, complete system providing high level of safety
- Defined workspace for operators

CONVEYOR TECHNOLOGY

- Ability to integrate conveying system from various suppliers in efficient manner
- Transportation of drums on pallets

THE SYSTEM: DRUM TO MACHINE

- Clearly structured material flow
- Clear winding pattern at high speed

Cut length of material
 up to
7.200.000 metres cutting per year
 That equates to the distance from Black Forest, Germany to Alaska

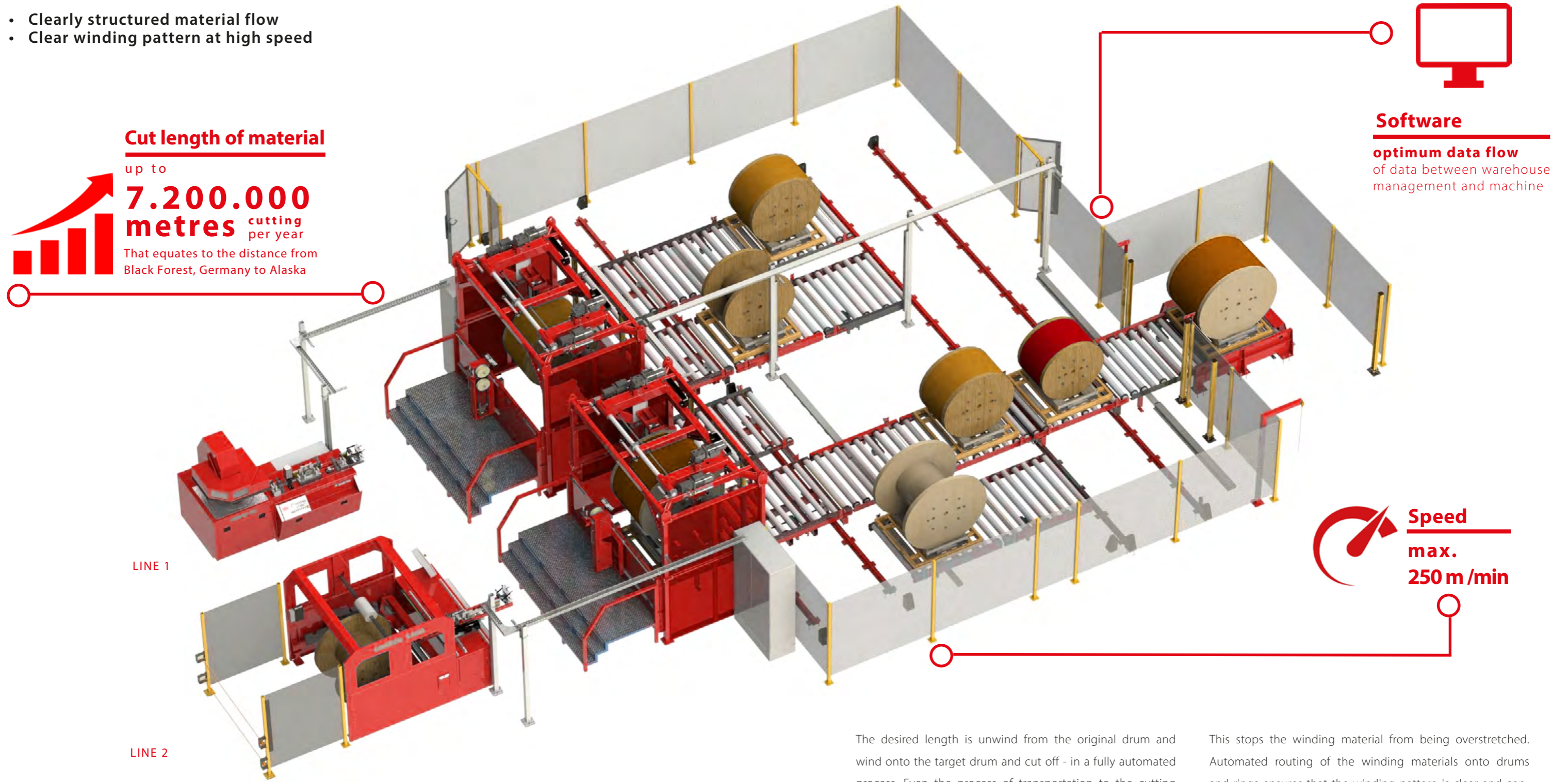

Software
 optimum data flow
 of data between warehouse management and machine

Speed
 max.
 250 m/min

The desired length is unwind from the original drum and wind onto the target drum and cut off - in a fully automated process. Even the process of transportation to the cutting machine is carried out by conveyor systems. The winding and unwinding processes take place at the same time. The winder and unwinder are driven by one motor each and synchronised using an electronic traction monitor.

This stops the winding material from being overstretched. Automated routing of the winding materials onto drums and rings ensures that the winding pattern is clear and consistent. During this process, the cutting data is logged and then archived by calibrated length measurement devices. In this way, it is possible to trace each order position using its individual drum data right through to the production process.

We move big drums

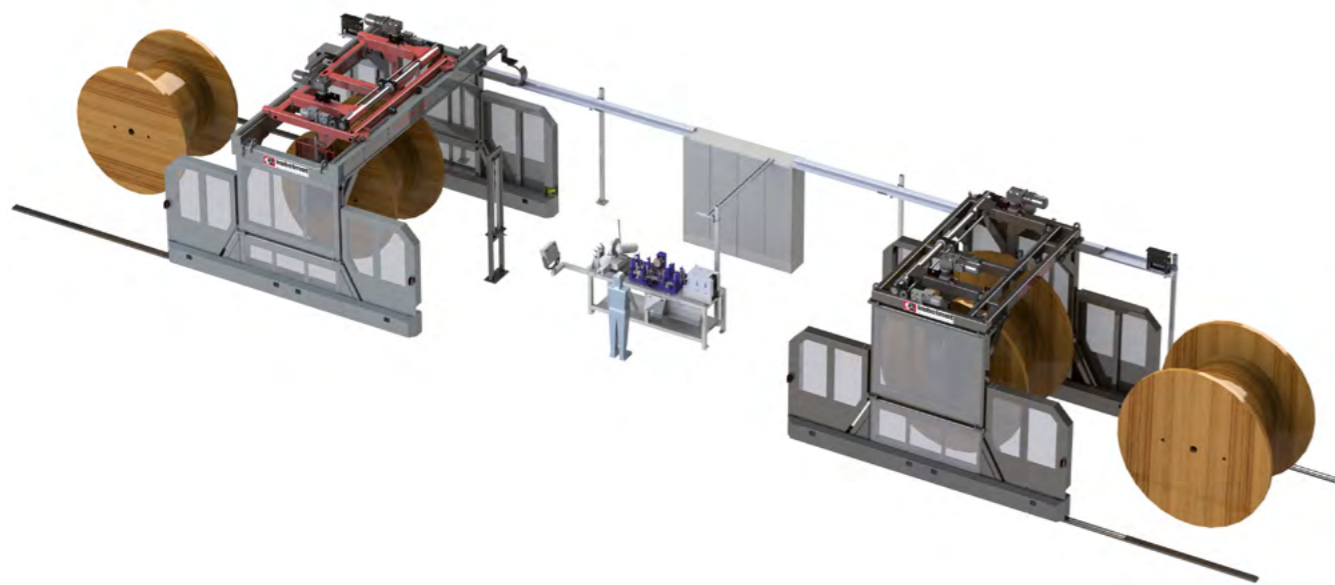

Fig. 1 PORTROL 3000 TELE-ABW / PORTROL 2600 TELE-AUF

PORTROL

Winding line for heavy drums

Wrapping machines for the heavy duty range are used for the cutting and wrapping of winding materials for high energy transfer as well as for data transfer in the copper and glass fibre field. This requires drums of a large diameter due to the maximum admissible bending radius and the big cutting lengths for energy transfer over long distances.

For this purpose Kabelmat has developed machines for drum sizes of up to:

Drum diameter	up to 3.000 mm
Drum weight	up to 10.000 kg
Winding material-Ø	up to 100 mm

Due to the tough and time-consuming rolling in of the heavy drums, these machines are now available with a running gear mounted on rails. This mobile unit facilitates work considerably.

In addition, these machines are driven by powerful servomotors and are equipped with digital servo-converters with Profinet interface. The complete line is speed-controlled. The unwinder is also equipped with a motorised drive for the winding operation with instantaneous control.

Length measuring devices are available of contactless laser measuring design or the well proven MESSBOI 100 with electronic preselection counter, always with permission for the movement of goods requiring calibration. The suitable cutter is also available.

Basic equipment:

- Steel frame of solid design, stationary screwed down onto the floor
- Steel frame of solid design, mobile on rails
- Very simple and easy material holding fixture with spindle sleeve arms driven by electric motor. The spindle sleeve arms move completely together so that even very narrow drums can be taken up
- Internal frame with the complete spindle sleeve unit for drum receipt traversing via AC geared motor
- Drum holder takes place via quick-change cones and a one-sided driver wing with sliding drive pin
- Winding drive consisting of AC geared motor with frequency converter
- The functions lifting/lowering as well as clamping/opening of the spindle sleeve arms via electric spindle drive together by pressing a button. The clamping force is limited by a set torque
- Hanging buttons for operating the functions lifting/lowering, clamping/opening, positioning of the drum
- Lateral sheet metal covering in the area of the sleeve arms against the intervention in the winding area
- Drum lowering protection
- Material return detection
- CE declaration of conformity according to Machinery Directive 2006/42/EG
- Electrical switch cabinet implemented in the machine

Recommended equipment:

- **Speed-controlled gear motor** depending on technical specifications
- **Frictionally engaged drum driver** with sleeve for easy loading of the drum without carrier bolts. Consisting of two carriers for both pintle arms. Cylindric drum loading.
- **ACUMATIC, material accumulator / dancer**
- **Instantaneous regulation of winding drive**



Fig. 2 ACUMATIC: material accumulator / dancer for controlling and synchronization of the drive of the drum. Necessary for tension sensitive winding goods.



Fig. 3 PORTROL 2500 AWB

PORTROL 3000 ABW - PORTROL 2600 AUF

Synchronised working drives will not only avoid an overstretching of the winding material, but also ensure a perfect laying patter

Equipment:

Portal unwinder PORTROL 3000

- Mobile version for an easy assembling of heavy drums
- Telescopic arms for drum take-up
- Frequency controlled winding drive with AC-drive engine
- Safety laser scanner for area safeguarding
- Device table with mounted length measuring device MESSBOI 100, cutter and guiding

Portal unwinder PORTROL 2600

- Mobile version for an easy assembling of heavy drums
- Telescopic arms for drum take-up
- Frequency controlled winding drive with AC-drive engine
- Safety laser scanner for area safeguarding
- Traversing via guiding unit for an exactly winding pattern of the material

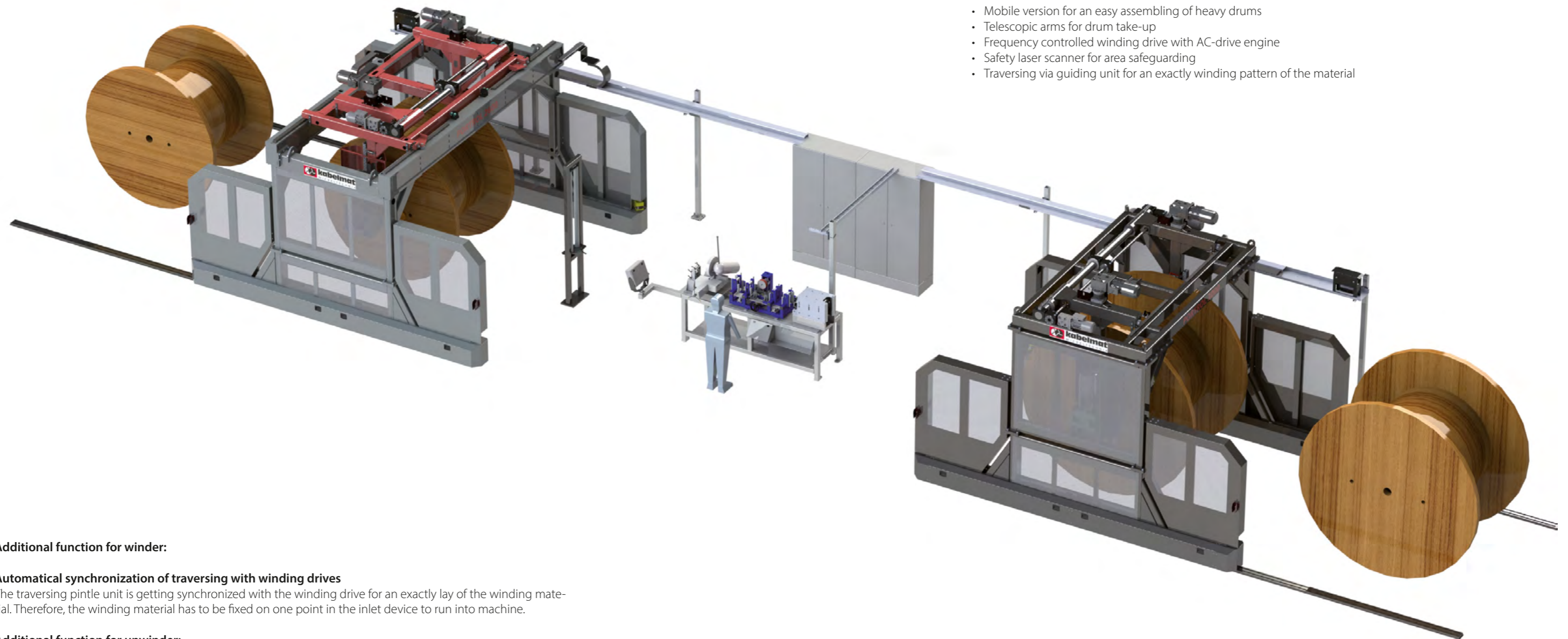

Additional function for winder:

Automatic synchronization of traversing with winding drives

The traversing pintle unit is getting synchronized with the winding drive for an exactly lay of the winding material. Therefore, the winding material has to be fixed on one point in the inlet device to run into machine.

Additional function for unwinder:

Follow-up control of the traversing via sensors

Due to follow-up control, rigid cables and wires are guided straight through the winding line. That has the advantage that there are no unnecessary bends and a gentle winding process is guaranteed.

LENGTH MEASURING SYSTEMS

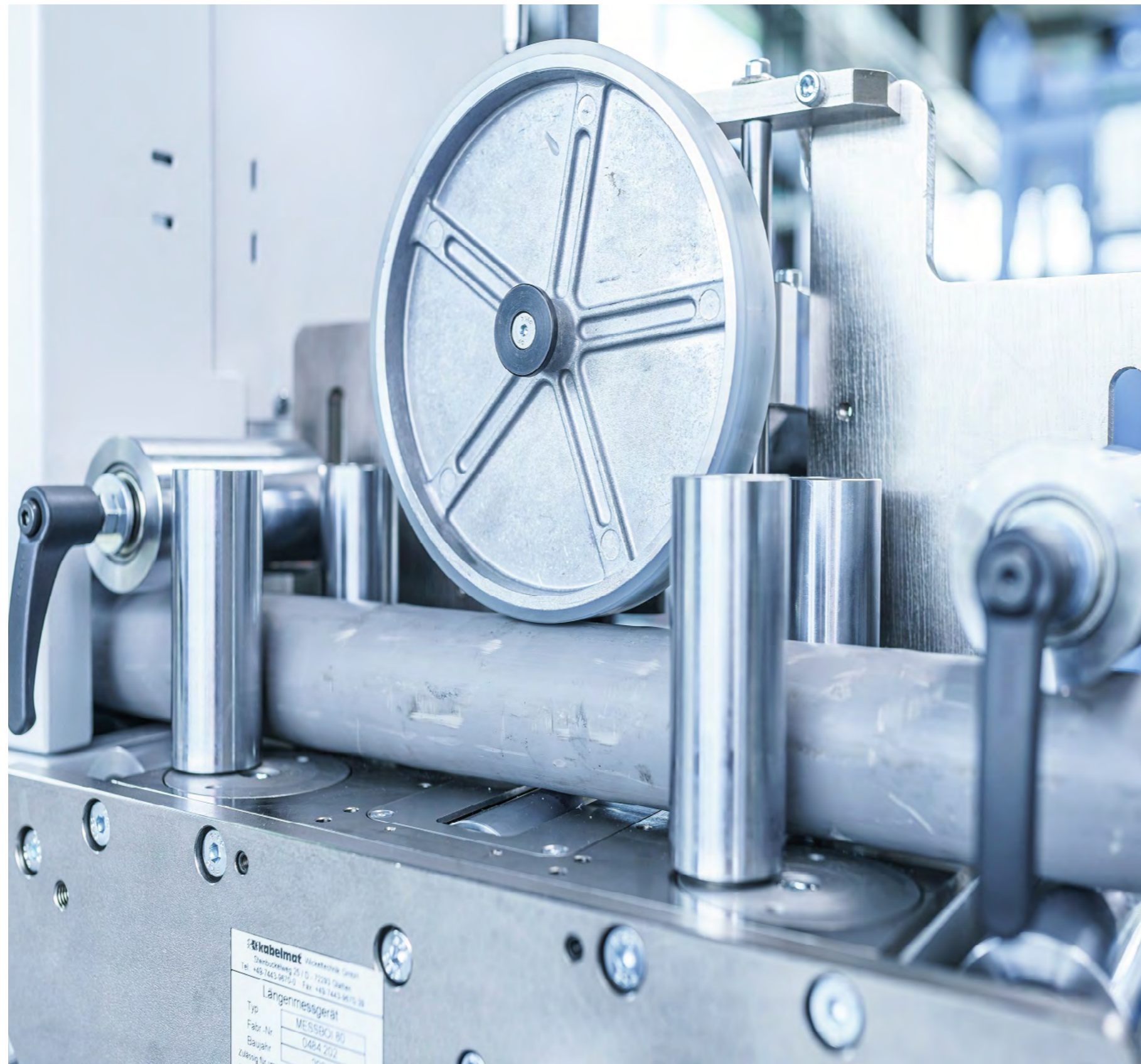

PRODUCTS

• Conformity assessment	92
• MESSBOI 10	94
• MESSBOI 25	96
• MESSBOI 40 B LC / LC-MID	97
• MESSBOI 40 BAE	98
• MESSBOI 40 LC / LC-MID	100
• MESSBOI 80 LC / LC-MID	103
• MESSBOI 100 LC / LC-MID	104
• MESSBOI 100 LASER	105

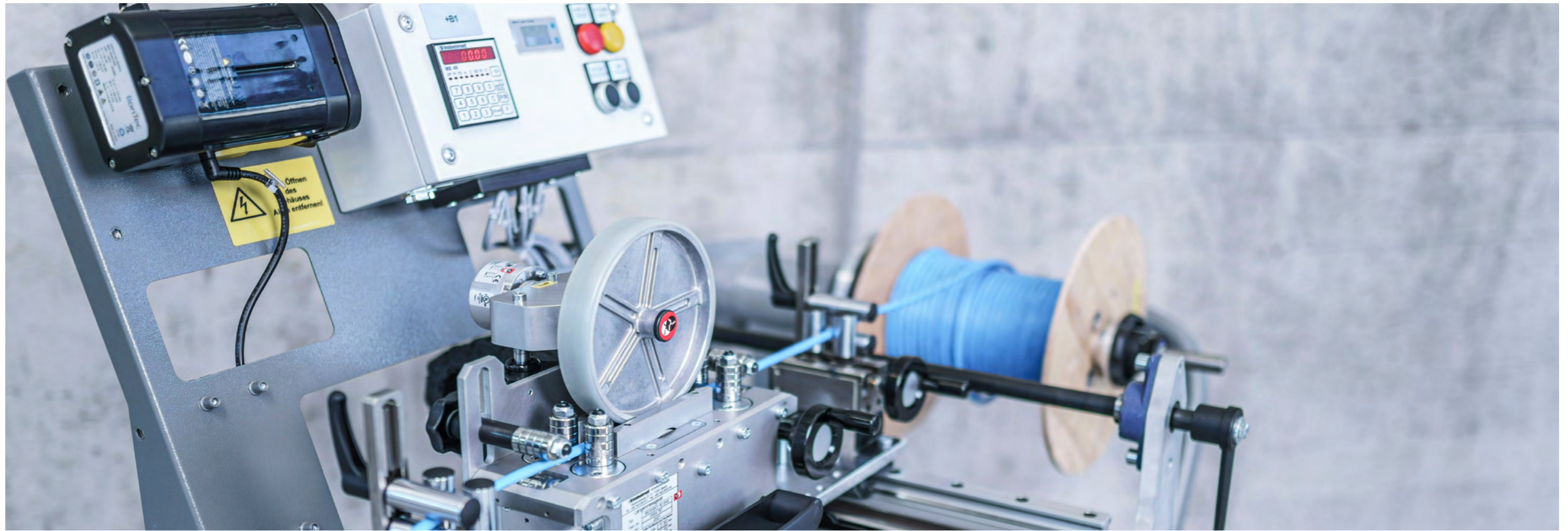

Fig. 1 MESSROL 500 with MESSBOI 40 LC -MID

Conformity assessment

We answer frequently asked questions

First conformity assessment - then calibration

The calibration regulation was previously regulated nationally. A conformity-assessed (MID compliant) length measuring system can now be used in all member states of the EEA. Companies that would like to sell the cables to third parties on the market may only use length measuring devices that correspond to the requirements of the new measuring device directive in future.

What has actually changed?

In addition to correct measurement of lengths, the requirements for logging, transparency and traceability of the measurements have been significantly increased. In the case of length measuring devices, the legislator wants to achieve in the long term that customers can be presented with a recorded measurement result upon request. This is only possible with an electronic counter with integrated measured value memory.

The core requirement is a permanent and tamper-proof storage of all measurements. All length cutting data must be archived, such as time, date, cut length, counter and measurement ID number. Furthermore, these data must be verifiably documented on the business documents for the buyer. For this, Kabelmat offers a label printer. This provides both the buyer and seller with 100% transparency and traceability, also with individually pre-cut products. New machines from Kabelmat satisfy the requirements of this directive.

What about length measuring devices with mechanical counter?

Kabelmat length measuring devices with mechanical counters can also be conformity assessed according to module F1, but are then only approved for direct sale (e. g. retail). There is an unlimited calibration period for these devices.

How long does the validity of conformity assessment (calibration period) last?

Electronic length measuring systems with a declaration of conformity are regarded as calibrated until the respective nationally regulated calibration period expires. For Germany, the calibration period for machines on the market is two years. Calibration (previously re-calibration) is then the responsibility of the measuring system owner. The regional weights and measures office of the owner is then responsible for calibration. Irrespective of the above, the calibration period ends when the error limit is exceeded or the seals have been prematurely damaged. Other countries may have deviating regulations. These can be found in the applicable national directives.

Conformity assessment module F

Conformity assessment according to module F (according to the European Measuring Instruments Directive 2014/32/EU) of the Kabelmat length measuring devices with additional inlet and outlet roller cages by the German calibration authority. Valid for two years in the EEA. The assessment is carried out at the Kabelmat manufacturing plant. Re-assessment after two years is required, but is not included in the scope of delivery. The authority for this is the regional weights and measures office. Note: Conformity assessment according to module F is required if the customer is not present when the goods (cables ect.) are cut. Required: Storage of the cutting data and documentation of the cutting data on the business records.

Conformity assessment module F1

Conformity assessment according to module F1 (according to the European Measuring Instruments Directive 2014/32/EU) of the Kabelmat length measuring devices with additional inlet and outlet roller cages by the German calibration authority. Valid for an unlimited period in the EEA. The assessment is carried out at the Kabelmat manufacturing plant. Re-assessment after two years is not required, but maintenance by Kabelmat is recommended. Note: Conformity assessment according to module F1 is only permitted if the customer is present when the goods (cables ect.) are cut. Not required: Storage of the cutting data and documentation of the cutting data on the business records.

When is a conformity assessment not required?

Conformity assessment is required when companies place unprocessed cables on the market. A conformity assessment is not required if the cable is further processed, e.g. a connector is attached.

MESSBOI 10

Length measuring device with mechanical counter

Compact length measuring device for small material diameters

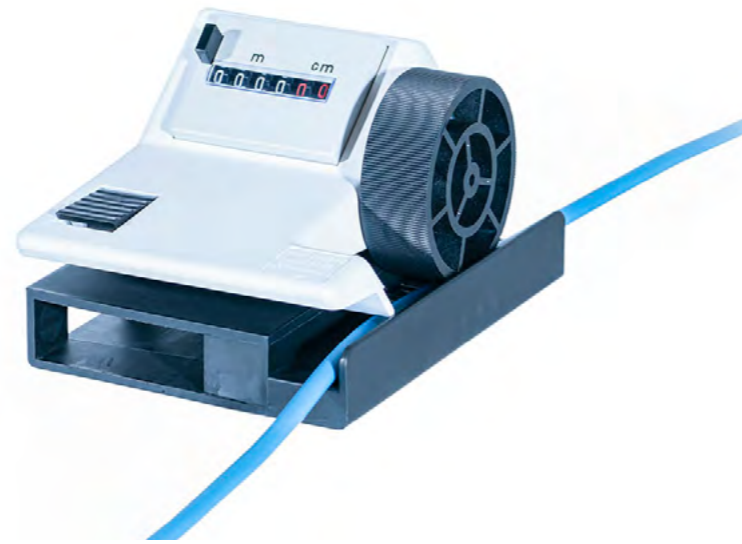

Fig. 1 MESSBOI 10

MESSBOI 10

- Mechanical length measuring device for winding material-Ø max. 15 mm

Functionality:

This length measuring device is suitable for length measuring of winding goods like cables and wires. The device is available in different versions according to the application.

- Avoiding material loss
- Compact design
- High measuring accuracy
- Simple construction and handling
- Adding mechanical counter with reset button

Length measuring device

Technical data	MESSBOI 10
Part No.	85100471
Measuring range	1 - 15 mm
Measuring force	Spring pressure
Error limit	+ / - 2 %
Display of counter	9999,99 m
L x W x H	approx. 160 x 110 x 90 mm
Housing	Polystyrene
Colour	black / white
Weight	approx. 0,5 kg
With mounting bracket	-



Fig. 2 MESSBOI 10

MESSBOI 10

Length measuring device with mechanical counter

Length measuring device with mounting bracket

Technical data	MESSBOI 10 B
Part No.	85100543
Measuring range	1 - 15 mm
Measuring force	Spring pressure
Error limit	+ / - 2 %
Display of counter	9999,99 m
L x W x H	approx. 260 x 110 x 140 mm
Housing	Polystyrene
Colour	black / white
Weight	approx. 0,7 kg
With mounting bracket	✓



Fig. 3 MESSBOI 10 with mounting bracket

Length measuring device with hand grip

Technical data	MESSBOI 10 HT
Part No.	85100442
Measuring range	1 - 15 mm
Measuring force	Spring pressure
Error limit	+ / - 2 %
Display of counter	9999,99 m
L x W x H	approx. 250 x 110 x 250 mm
Housing	Polystyrene
Colour	black / white
Weight	approx. 1,0 kg



Fig. 4 MESSBOI 10 HT with hand grip

Length measuring device for flat material

Technical data	MESSBOI 10 FLA
Part No.	85100443
Measuring range W x H	100 x 15 mm
Measuring force	Spring pressure
Error limit	+ / - 2 %
Display of counter	9999,99 m
L x W x H	approx. 160 x 210 x 90 mm
Housing	Polystyrene
Colour	black / white
Weight	approx. 0,75 kg



Fig. 5 MESSBOI 10 FLA for flat material

MESSBOI 25

Length measuring device with mechanical counter

Mobile as a hand-held device or stationary use



Fig. 1 MESSBOI 25 with socket and hand grip

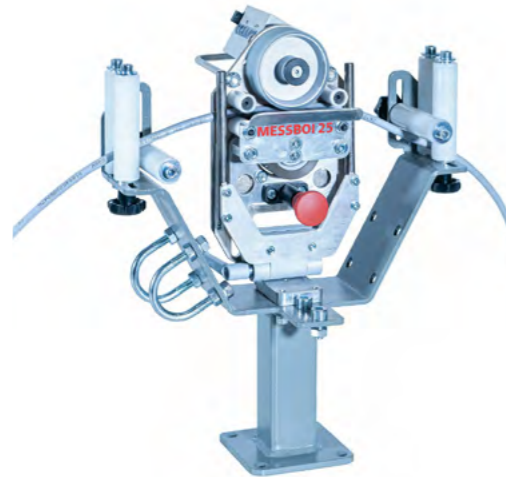

Fig. 2 MESSBOI 25 with roller cage unit



Fig. 3 MESSBOI 25 with hand grip

MESSBOI 25

- Mechanical length measuring device for winding material-Ø max. 25 mm

Functionality:

The length measuring device is suitable for measuring the length of almost all types of cables and similar winding goods. The device can be used both as a hand-held device and as a stationary device. For portable use the screws have to be loosened by the socket and the length measuring device can be removed from the socket. Counter wheel detent and a clamp which can be opened to the side enables a convenient insertion of winding goods.

- Counter with reset button
- Continuously adjustable cable guiding
- Aluminium measuring wheel with vulcanized PUR coating
- Socket in the scope of delivery contained
- Non-slip hand grip
- Available with separately roller cage unit

Technical Data	MESSBOI 25	MESSBOI 25 conformity assessed*
Part No.	85101000	86101000
Measuring range	2 - 25 mm	2 - 15 mm
Error limit	+ / - 0,5 %	+ / - 0,5 %
Display of counter	9999,99 m	9999,99 m
L x W x H	approx. 120 x 160 x 350 mm	approx. 120 x 160 x 350 mm
Colour	aluminum / silver	aluminum / silver
Colour socket	RAL 7005 mouse grey	RAL 7005 mouse grey
Weight without socket	approx. 1,4 kg	approx. 1,4 kg
Weight socket	approx. 0,7 kg	approx. 0,7 kg

Equipment	Inlet and outlet roller cage unit
Part No.	85101001
Roller cage unit for better guidance of the winding goods. Required for MESSBOI 25 conformity assessed.	

*Conformity assessment of the length measuring device according module F1 with additional inlet and outlet roller cage is approved by German calibration authority. Valid for an unlimited period in the EEA. Conformity assessment has to be carried out in the manufacturing firm. Re-assessment after two years is not required, but maintenance by Kabelmat is recommended. **Only approved for useage in direct sales!**

MESSBOI 40 B LC / LC-MID

Length measuring device with digital counter

Length measuring for various winding material

MESSBOI 40 B LC / LC-MID

- Digital belt length measuring device for winding material-Ø max. 40 mm

Functionality:

This length measuring device is used for round and flat material such as cables, pipes, hoses, ropes of all kind. It is perfectly suited for high measurement precision and low measurement tolerances. The chassis consists of a stainless steel casing in which above all the sensitive components are well protected against outer influences. The scanning of the material to be measured is ensured by two measuring tape units running against each other. The top tape unit is liftable by means of a knee lever and due to its coordinated own weight adapts itself to the thickness of the material to be measured. For registration the length, the bottom measuring unit is provided with a rotary pulse encoder.

Technical data	MESSBOI 40 B LC / LC-MID
Part No.	0405.000
Round cable-Ø with MID / conformity assessment	1 - 40 mm
Tube-Ø with MID / conformity assessment	2 - 40 mm
Steel cable-Ø with MID / conformity assessment	2 - 15 mm
Thickness range flat cable with MID / conformity assessment	1 - 15 mm
Width range flat cable with MID / conformity assessment	10 - 40 mm
Speed conformity assessed	max. 250 m / min
Circumference of measuring wheel	0,5 m
Rotary pulse encoder	500 Imp / per turn 24 VDC
Error limit regarding accuracy class III with roller cages	+ / - 0,5 %
Display of counter	99999,999 m
L x W x H (without roller cages)	approx. 500 x 300 x 500 mm

Basic equipment:

- One set of inlet and outlet rollers with adjustable width
- Measuring tape with manual column-type measuring wheel adjustment
- Flange for a second rotary pulse encoder, provided for in the stainless steel casing
- Preselection counter and rotary pulse encoder integrated in the stainless steel casing
- A preselection counter LC MID with two potential-free electric contacts for controlling the fast motion / inching function of an adjustable winding drive. The counter is equipped with a plastic foil keyboard for inputting the data.
- Supervision of the calibrating speed with a luminous indicator

Supplementary equipment:

- Tripod stand for floor mounting (Height adjustable 1320 - 1620 mm) or stand for table mounting
- Holding arm with inlet and outlet roller cage
- Manual height locking device of the measuring wheel
- Conformity assessment / MID (formerly first calibration) of the length measuring device according module F with additional inlet and outlet roller cages is approved by German Authorities for a period of two years from date of delivery, valid for all EEA Member States. Conformity has to be carried out in the manufacturing firm. Prolongation of this approval after 2 years had expired is not included in the delivery
 - Automatic storage of the cutting data
 - Label printer with interface to the preselection counter
 - Holder for label printer

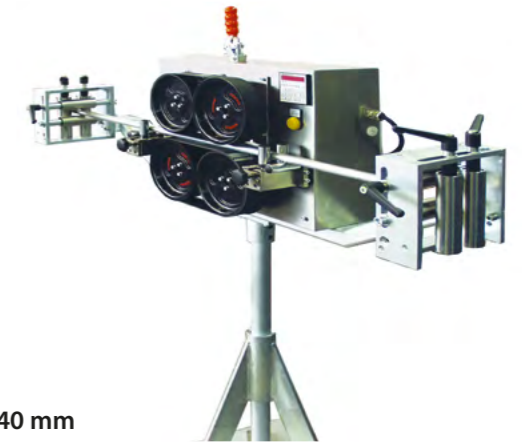

Fig. 1 MESSBOI 40 B LC with tripod stand



Abb. 2 MESSBOI 40 B LC

MESSBOI 40 BAE

Length measuring device with mechanical counter

Mechanical length measuring with modular design

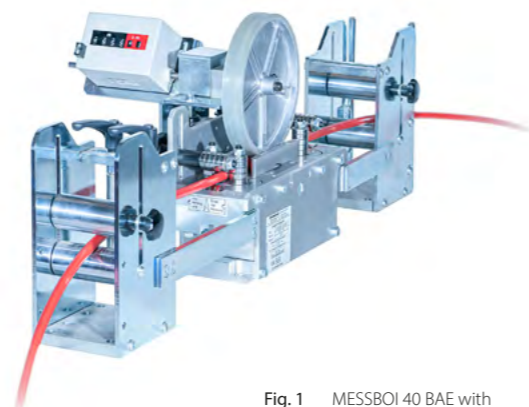

Fig. 1 MESSBOI 40 BAE with inlet and outlet roller cages

MESSBOI 40 BAE

- Mechanical length measuring device for winding material-Ø max. 40 mm

Functionality:

Length measuring device for winding goods up to an outer diameter of 40 mm with mechanical counter. Depending on the application we offer various versions to customer specification. These measuring devices consist of a solid base frame with guide rollers to which the measuring device is mounted. Measuring scanning by means of measuring wheel. If requested, also available with stainless steel-counter roller for the measuring of steel ropes.

Basic equipment:

- One set of inlet and outlet rollers of adjustable height and centrally adjustable width
- Adding mechanical counter with reset button

Supplementary equipment:

- **Alu profile** with mounting plates for measuring device, roller cages, lever shear and housing for counter
- **Inlet and outlet roller cages**
- **Conformity assessment / MID (formerly first calibration)** of the length measuring device according module F1 with additional inlet and outlet roller cages is approved by German calibration authority for a period of two years from date of delivery, valid for all EEA member states. Conformity assessment has to be carried out in the manufacturing firm. Prolongation of this approval after 2 years had expired is not included in the delivery. **Only approved for useage in direct sales!**

Basic device MESSBOI 40 BAE

Technical data	MESSBOI 40 BAE*
Part No.	85100003
Measuring range (with conformity assessment)	1 - 40 mm (2 - 25 mm)
Speed conformity assessed	max. 80 m / min
Circumference of measuring wheel	0,5 m
Error limit regarding accuracy class III with roller cages	+ / - 0,5 %
Display of counter	9999,99 m
L x W x H (without roller cages)	approx. 320 x 320 x 280 mm
Material	steel / stainless steel / aluminium
Weight	approx. 12 kg
* Note: MESSBOI 40 BAE is also available with stainless steel counter roller for wire rope or steel cable. Part No. 86000316	



Fig. 2 MESSBOI 40 BAE basic device

MESSBOI 40 BAE

Length measuring device with mechanical counter

Roller cages



Fig. 3 Inlet and outlet roller cages



Fig. 4 Inlet and outlet roller cages



Fig. 5 Inlet roller cage



Fig. 6 Inlet or outlet roller cage

Technical data	Inlet and outlet roller cages (pair)	Inlet and outlet roller cages (pair)	Inlet roller cage (piece)	Inlet or outlet roller cage (piece)
Part No.	85100185	85100186	85100189	86001454
Suitable for MESSBOI 40 BAE	✓	✓	✓	✓
For winding from an unwinder	✓	-	-	✓
For winding out of a drum rack	-	✓	✓	-
Rollers horizontal adjustable	✓	✓	✓	✓
Rollers horizontal and vertical adjustable	✓	✓	-	✓
Material-Ø	max. 40 mm	max. 40 mm	max. 40 mm	max. 40 mm
Guide outlet rollers-Ø	35 mm	35 mm	-	-
Guide inlet rollers-Ø	35 mm	80 mm	80 mm	35 mm
Weight	approx. 10 kg / pair	approx. 10 kg / pair	approx. 5 kg	approx. 5 kg
Housing	steel zinc-plated	steel zinc-plated	steel zinc-plated	steel zinc-plated
Guide rollers inlet	stainless steel	plastic	plastic	stainless steel
Guide rollers outlet	stainless steel	stainless steel	-	-

Conformity assessment

Technical data	Conformity assessment / MID (formerly first calibration)
Part No.	146
Conformity assessment of the length measuring device according module F1 with additional inlet and outlet roller cage is approved by German calibration authority. Valid for an unlimited period in the EEA. Conformity assessment has to be carried out in the manufacturing firm. Re-assessment after two years is not required, but maintenance by Kabelmat is recommended. Only approved for useage in direct sales!	

Alu profile and lever shear

Technical data	Alu profile for MESSBOI 40 for mounting onto MESSROL 670 / 1000
Part No.	86100005
With mounting plates for roller cages, measuring device and lever shear	
Technical data	MATIS 40 lever shear for cable (fine-wire)
Part No.	86001132
Material-Ø	max. 40 mm
B x W x H	approx. 110 x 130 x 720 mm
Weight	approx. 8,3 kg
Material	Blades made of hardend tool steel
Cut release via hand lever.	



Fig. 7 Alu profile with MESSBOI 40 BAE, MATIS 40 and inlet and outlet roller cages



Fig. 8 MATIS 40 lever shear

Indoor use only.
Fig. may differ from original.
Technical modifications reserved.

MESSBOI 40 LC / LC-MID

Length measuring device with digital counter

Data storage for a permanent and tamper-resistant storage of all measurements

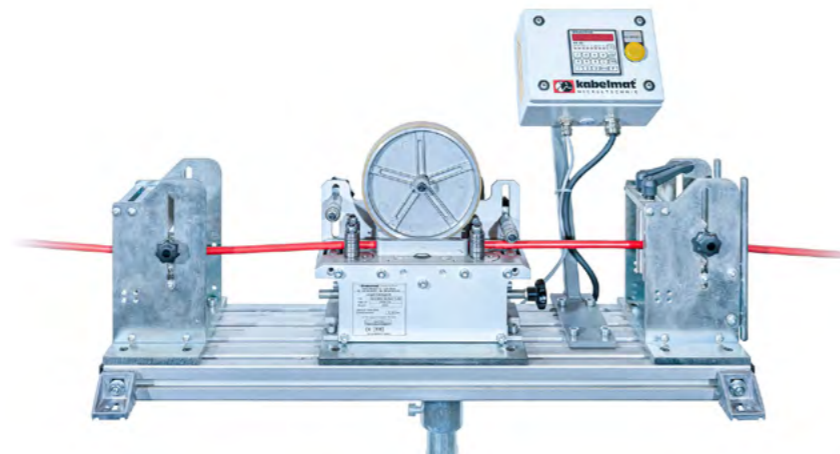

Fig. 1 MESSBOI 40 LC with counter in housing, aluminium profile, inlet and outlet roller cages, printer holder and printer

MESSBOI 40 LC / LC-MID

- Digital length measuring device for winding material-Ø max. 40 mm

Functionality:

Length measuring device with digital counter. Depending on the application we offer various versions due to customer specification. This measuring device consists of a solid base frame with guide rollers to which the measuring device is mounted. Measuring scanning by means of measuring wheel.

Basic equipment:

- Preselection counter integrated in housing, mounted besides the measuring device
- One set of inlet and outlet rollers of adjustable height and centrally adjustable width
- A rotary pulse encoder with two channels A+B, 24 VDC and connection cable
- A preselection counter LC MID with interface RS 232 with two potential-free electric contacts for drive of high- / low speed function of an adjustable winding drive or a signal lamp. The counter is equipped with a plastic foil keyboard for inputting the data. Possibility of conformity assessment (formerly first calibration) of the length measuring device with Kabelmat - preset counter and rotary pulse encoder in connection with additional infeed and outfeed roller cages.
- The calibration speed is monitored by a signal lamp

Supplementary equipment:

- **Angle drive for easy operation of the central adjustment of vertical guides**
- **Cable end detection**
- **Sensor for measuring the cable diameter for automatic traversing and for switching off the winding drive at the cable end**
- **Inlet and outlet roller cages**
- **Conformity assessment / MID (formerly first calibration)** of the length measuring device according module F with additional inlet and outlet roller cages is approved by German Authorities for a period of two years from date of delivery, valid for all EEA Member States. Conformity has to be carried out in the manufacturing firm. Prolongation of this approval after 2 years had expired is not included in the delivery.
 - **Automatic storage** of the cutting data
 - **Label printer** with interface for preselection counter
 - **Printer holder** for label printer

MESSBOI 40 LC / LC-MID

Length measuring device with digital counter

Basic device MESSBOI 40 LC / LC-MID

Technical data	MESSBOI 40 LC / LC-MID
Part No.	85100455
With 2 potential-free change-over contact with pre-and limit switching	
Round cable-Ø with MID / conformity assessment	2 - 40 mm
Tube-Ø with MID / conformity assessment	2 - 40 mm
Steel cable-Ø with MID / conformity assessment	2 - 15 mm
Thickness range flat cable with MID / conformity assessment	2 - 15 mm
Width range flat cable with MID / conformity assessment	10 - 40 mm
Speed conformity assessed	max. 250 m / min
Circumference of measuring wheel	0,5 m
Rotary pulse encoder	500 Imp / per turn 24 VDC
Error limit regarding accuracy class III with roller cages	+ / - 0,5 %
Display of counter	99999,999 m
L x W x H (without roller cages)	approx. 400 x 310 x 400 mm
Weight	approx. 10 kg



Fig. 2 MESSBOI 40 LC with counter in housing

Roller cages



Fig. 3 Inlet and outlet roller cages



Fig. 4 Inlet and outlet roller cages



Fig. 5 Inlet roller cage



Fig. 6 Inlet or outlet roller cage

Technical data	Inlet and outlet roller cages (pair)	Inlet and outlet roller cages (pair)	Inlet roller cage (piece)	Inlet or outlet roller cage (piece)
Part No.	85100185	85100186	85100189	86001454
Suitable for MESSBOI 40 BAE	✓	✓	✓	✓
For winding from an unwinder	✓	-	-	✓
For winding out of a drum rack	-	✓	✓	-
Rollers horizontal adjustable	✓	✓	✓	✓
Rollers horizontal and vertical adjustable	✓	✓	-	✓
Material-Ø	max. 40 mm	max. 40 mm	max. 40 mm	max. 40 mm
Guide outlet rollers-Ø	35 mm	35 mm	-	-
Guide inlet rollers-Ø	35 mm	80 mm	80 mm	35 mm
Weight	approx. 10 kg / pair	approx. 10 kg / pair	approx. 5 kg	approx. 5 kg
Housing	steel zinc-plated	steel zinc-plated	steel zinc-plated	steel zinc-plated
Guide rollers inlet	stainless steel	plastic	plastic	stainless steel
Guide rollers outlet	stainless steel	stainless steel	-	-

MESSBOI 40 LC / LC-MID

Length measuring device with digital counter

Conformity assessment and accessory

Technical data	Conformity assessment / MID (formerly first calibration)
----------------	--

Part No. 242

Conformity assessment of the length measuring device according module F with additional inlet and outlet roller cages approved by German calibration authority for a period of two years from date of delivery, valid for all EEA member States. Conformity has to be carried out in the manufacturing firm. Prolongation of this approval after two years had expired is not included in the delivery. Presence of the customer is not needed.

Technical data	Label printer
----------------	---------------

Part No. 5101.000

With interface to the preselection counter
The company logo must be provided by the customer when ordering.
In *.bmp format, black / white, Resolution 200dpi, max. size: 45 x 20 mm (W x H)

Technical data	Printer holder
----------------	----------------

Part No. 85100949

Holder for label printer

Alu profile and lever shear

Technical data	Alu profile for MESSBOI 40 for mounting onto table
----------------	--

Part No. 86100006

With mounting plates for roller cages, measuring device and lever shear

Technical data	Alu profile for MESSBOI 40 for mounting onto MESSROL 670 / 1000
----------------	---

Part No. 86100005

With mounting plates for roller cages, measuring device, lever shear and housing for counter

Technical data	MATIS 40 lever shear for cables (fine-wire)
----------------	---

Part No. 86001132

Material-Ø max. 40 mm

B x W x H approx. 110 x 130 x 720 mm

Material Blades made of oxide ceramics

Weight approx. 8,3 kg

Cut release via hand lever.

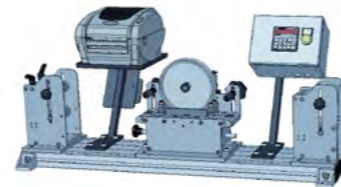

Fig. 7 MESSBOI 40 LC-MID with counter in housing, inlet and outlet roller cages, holder for label printer and label printer



Fig. 8 Label printer



Fig. 9 Example label with customer logo



Fig. 10 Alu profile



Fig. 11 MATIS 40 lever shear

Indoor use only.
Fig. may differ from original.
Technical modifications reserved.

MESSBOI 80 LC / LC-MID

Length measuring device with digital counter

Length measuring for big sizes

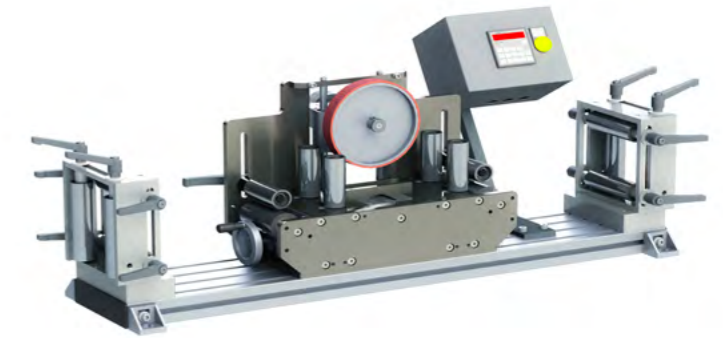

Fig. 1 MESSBOI 80 LC with housing and roller cages on alu profile

MESSBOI 80 LC / LC-MID

- Digital length measuring device for winding material-Ø max. 80 mm

Functionality:

This length measuring device consists of a solid base body with guiding rollers to which the measuring device is mounted. The scanning of the material to be measured is ensured by a measuring wheel.

Technical data	MESSBOI 80 LC / LC-MID
Part No.	0484.000
Round cable-Ø (with MID / conformity assessment)	2 - 80 mm (2 - 60 mm)
Steel cable-Ø with MID / conformity assessment	2 - 20 mm
Thickness range flat cable with MID / conformity assessment	2 - 20 mm
Width range flat cable with MID / conformity assessment	10 - 60 mm
Speed conformity assessed	max. 250 m / min
Circumference of measuring wheel	0,5 m
Rotary pulse encoder	500 Imp / per turn 24 VDC
Error limit regarding accuracy class III with roller cages	+ / - 0,5 %
Display of counter	99999,999 m
L x W x H (without roller cages)	approx. 510 x 270 x 310 mm
Weight	approx. 23 kg

Basic equipment:

- A casing fitted to the length measuring device for the counter
- The length is measured by a measuring wheel
- One set of inlet and outlet rollers of adjustable height and centrally adjustable width
- A rotary pulse encoder with connection cable
- A preselection counter LC MID with interface RS 232 with two potential-free electric contacts for controlling the fast motion/ inching function of an adjustable winding drive or a luminous indicator. The counter is equipped with a plastic foil keyboard for putting the data. Possibility of a conformity assessment (formerly first calibration) of the length measuring device with Kabelmat preselection counter and rotary pulse encoder in connection with additional inlet and outlet roller cages.
- Supervision of the calibration speed with luminous indicator

Supplementary equipment:

- **Diameter recognition mounted on the MESSBOI 80 LC / LC-MID** to determine the diameter of winding good
- **Conformity assessment / MID (formerly first calibration)** of the length measuring device according module F with additional inlet and outlet roller cages is approved by German Authorities for a period of two years from date of delivery, valid for all EEA Member States. Conformity has to be carried out in the manufacturing firm. Prolongation of this approval after 2 years had expired is not included in the delivery.
 - **Automatic storage** of the cutting data
 - **Label printer** with interface to the preselection counter
 - **Holder** for label printer

Indoor use only.
Fig. may differ from original.
Technical modifications reserved.

MESSBOI 100 LC / LC-MID

Length measuring device with digital counter

Length measuring device for big material

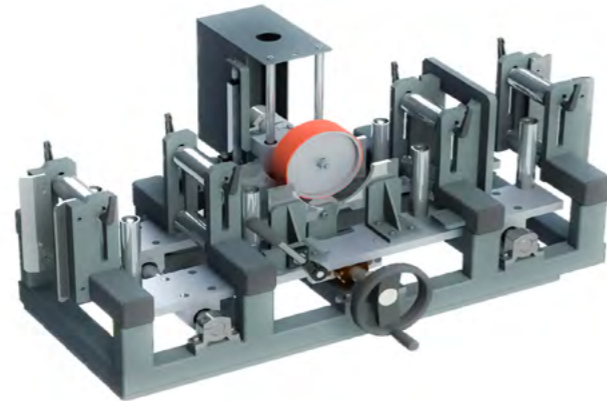

Fig.1 MESSBOI 100 LC with pre-selection counter in housing

MESSBOI 100 LC / LC-MID

- Digital length measuring device for winding material-Ø max. 100 mm

Functionality:

This length measuring device consists of a solid base body with guiding rollers to which the measuring device is mounted. The scanning of the material to be measured is ensured by a measuring wheel.

Technical data	MESSBOI 100 LC / LC-MID
Part No.	0492.000
Round cable-Ø with MID / conformity assessment	5 - 100 mm
Thickness range flat cable with MID / conformity assessment	4 - 20 mm
Width range flat cable with MID / conformity assessment	10 - 100 mm
Speed with MID / conformity assessment (depending on material)	max. 150 m / min
Circumference of measuring wheel	0,5 m
Rotary pulse encoder	500 Imp / per turn 24 VDC
Error limit regarding accuracy class III with roller cages	+ / - 0,5 %
Display of counter	99999,999 m
L x W x H (without roller cages)	approx. 1100 x 550 x 450 mm
Weight	approx. 80 kg

Basic equipment:

- Four sets of inlet and outlet rollers, adjustable in height and centrally adjustable in width
- Mechanical measuring wheel mounted on two pillar guides
- The length is measured by a measuring wheel
- Measuring wheel rests on the material due to its dead weight
- A rotary pulse encoder with connection cable
- A preselection counter LC MID with interface RS 232 with two potential-free electric contacts for controlling the fast motion / inching function of an adjustable winding drive or a luminous indicator. The counter is equipped with a plastic foil keyboard for inputting the data. Possibility of a conformity assessment (formerly first calibration) of the length measuring device with Kabelmat preselection counter and rotary pulse encoder in connection with additional inlet and outlet roller cages.
- Supervision of the calibration speed with luminous indicator.

Supplementary equipment:

- **Diameter recognition mounted on the MESSBOI 100 LC / LC-MID** to determine the diameter of winding good
- **Conformity assessment / MID (formerly first calibration)** of the length measuring device according module F with additional inlet and outlet roller cages is approved by German Authorities for a period of two years from date of delivery, valid for all EEA Member States. Conformity has to be carried out in the manufacturing firm. Prolongation of this approval after 2 years had expired is not included in the delivery.
 - **Automatic storage** of the cutting data
 - **Label printer** with interface to the preselection counter
 - **Holder** for label printer

MESSBOI 100 LASER

Length measuring device with contactless length measuring

Contactless length measuring



Fig. 1 MESSBOI 100 LASER

MESSBOI 100 LASER

- Laser length measuring device for winding material-Ø max. 100 mm

Functionality:

Contactless length measuring device with roller guides working as per the laser-doppler principle, certified as per MID. Specially developed device for installation in length measuring lines which require calibration.

Technical data	MESSBOI 100 LASER
Part No.	0495.000
Measuring range (differing with conformity assessment)	4 - 100 mm
Speed	max. 5000 m / min
Electrical supply	110 - 240 V / 50 Hz
L x W x H	approx. 1100 x 550 x 450 mm
Weight	approx. 100 kg

Basic equipment:

- Basic unit with manual height adjustment
- Basic unit with motorized height adjustment
- Inlet and outlet rollers of adjustable height and centrally adjustable width
- Very high reproducibility - better 0.02%
- Very high absolute accuracy - better 0.05%
- No slippage - even at very high speeds and accelerations
- No wear or abrasion
- Multi-function display
- Interface module for storing the data
- Two potential-free electrical contacts for controlling the rapid / creep speed function of a controllable winding drive or a light-emitting indicator

Supplementary equipment:

- **Laser protective housing** mounted on length measuring device
- **Laser measuring head with intergrated direction detection**
- **Roller guide** vertically and horizontally adjustable
- **Inlet and outlet roller cages**
- **Diameter detection mounted on the MESSBOI 100 LASER** to determine the winding material diameter
- **Conformity assessment / MID (formerly first calibration)** of the length measuring device according module F with additional inlet and outlet roller cages is approved by German Authorities for a period of two years from date of delivery, valid for all EEA Member States. Conformity has to be carried out in the manufacturing firm. Prolongation of this approval after 2 years had expired is not included in the delivery.
 - **Automatic storage** of the cutting data
 - **Label printer** with interface to the preselection counter
 - **Holder** for label printer

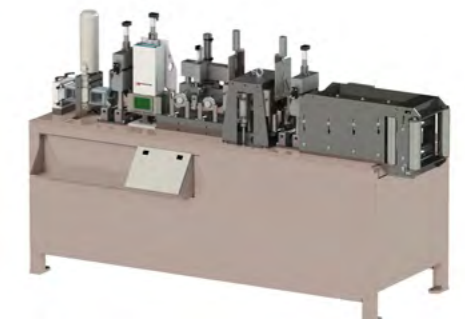
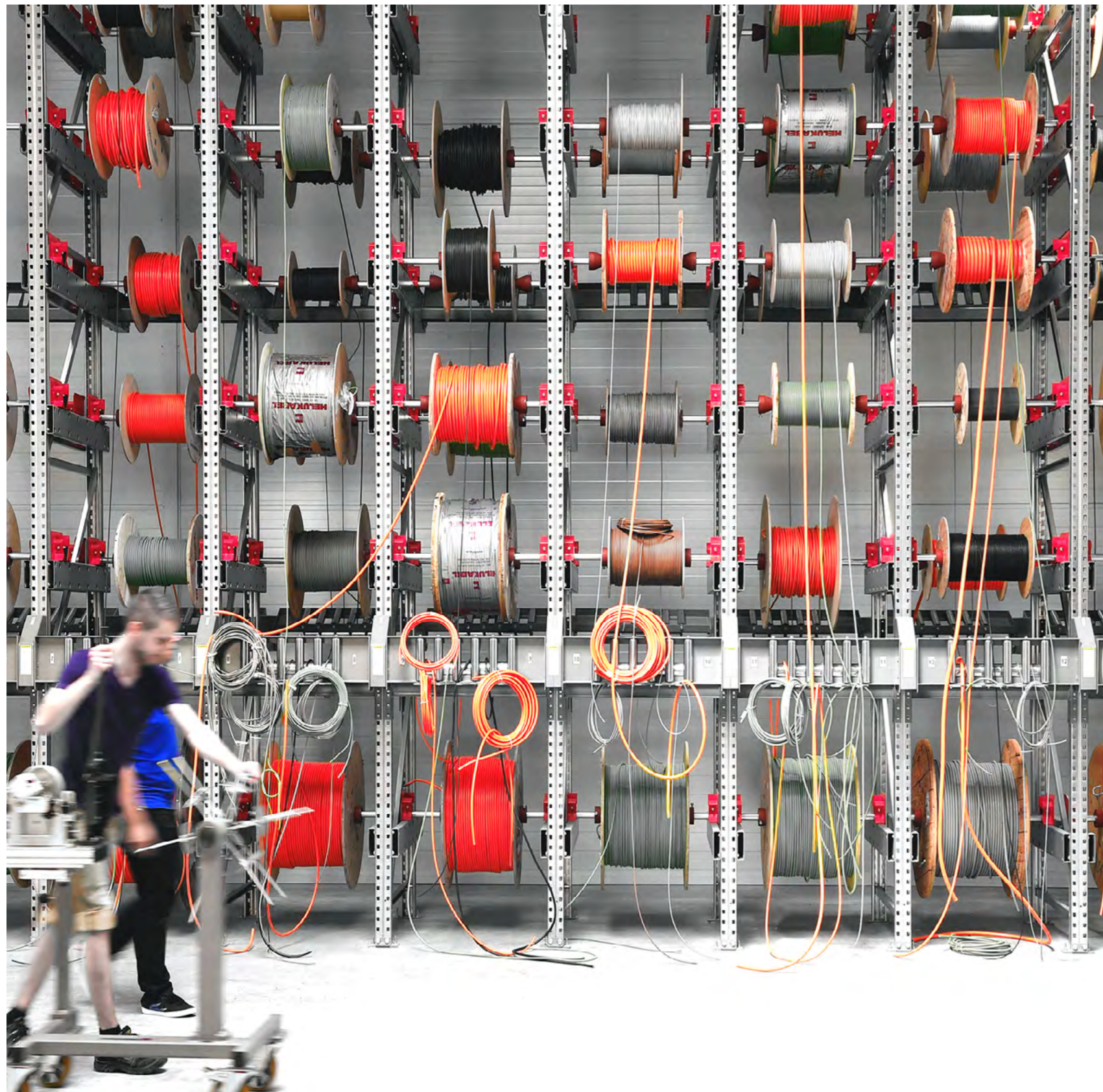

Fig. 2 Example MESSBOI LASER, length measuring unit with guides and roller feed for semi-automatic infeed

STORAGE SYSTEMS AND ACCESSORIES



PRODUCTS

- MATBOI 108
- SPULBOI 112
- LAGBOI 2200 / 3000 116
- LAGROL 118
- ABROL 123
- TROMSTOP 124
- TROMPLAT 1000 / 2500 125
- SPULROLLY 126
- TROMBULLY 127

Time-saving storage and unwinding of coils, tubes and plastic pipes

**Do you want to store coils and spools?
No problem - A combination is possible.**

» Find more information at SPULBOI storage system



Fig. 1: MATBOI / SPULBOI Combination

MATBOI

- Storage and unwinding system for coils, tubes and plastic pipes

Fuctionality:

This storing system is mainly used in workshop or production areas. It allows clearly ordered storing and entangling-free pulling-off according to demand. The mobile version or stationary version as wall rack offers a large variety of applications. Twisting-free material unwinding, simultaneous measuring and cutting-to-length of winding material such as cables, tubes or profiles wound on commercial coils are possible. The coils are stored clearly and are ready for unwinding.

Our unwinding and storage plates for larger coils can be slided sideways via swivel arms. This ensures easy storage and removal of the coils. A central adjustment of the clamping bolts assured a simple and continuous tension of the coils.

An additional bouncing protection consisting of border bolts and cover plate avoids against bouncing of single winding layers.

The unwinding plates are made of winding-friendly surfaces and are equipped with a brake to prevent the material for avoiding an unconditional material flow during unwinding process.

- Mobile storage device
- Length measurement possible
- Easy assembly and removal of the coils (coils are stored separately)

Complete device



Fig. 2: MATBOI complete device

Complete device	MATBOI
Part No.	85100670
Components	consisting of:
1 pcs. storage rack	85101500
2 pcs. MATBOI 450 T	85100159
3 pcs. MATBOI 300 T	85100157
1 pcs. MATBOI 200 T	85100155
Technical data	
H x W x D	approx. 1780 x 1040 x 700 mm
Colour	RAL 7005 mouse grey
Weight	approx. 100 kg

Storage rack / Wall profile rail



Fig. 3: Storage rack 650

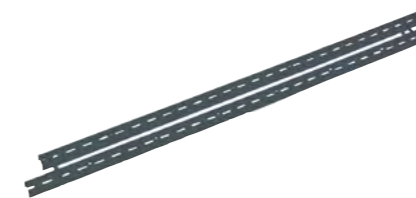

Fig. 4: Wall profile rail

Coil storing units - horizontal



Fig. 5: MATBOI 200 T



Fig. 6: MATBOI 300 T

Technical data	Storage rack 650 mobile
Part No.	85101500
H x W x D	approx. 1780 x 1040 x 700 mm
Loading capacity	max. 200 kg
Weight	approx. 42 kg
Colour	RAL 7005 mouse grey
Incl. 4 brakeable rollers.	

Technical data	Attachment piece for storage rack
Part No.	86181001
H x W x D	approx. 60 x 30 x 315 mm

Complete unit incl. clamping rail and screws to extend storage rack about 300 mm.
Note: Not suitable for MATBOI 480 T and MATBOI 650 T unit!

Technical data	Wall profile rail (pair)
Part No.	85100201
H x W x D	approx. 980 x 30 x 13 mm
Weight	approx. 1 kg
Colour	RAL 7005 mouse grey

For mounting SPULBOI and MATBOI units.
Note: Not suitable for MATBOI 480 T and MATBOI 650 T unit!

Technical data	MATBOI 200 T
Part No.	85100155
Plate Ø	200 mm
Coil Ø	max. 190 mm
Height centering pins	110 mm
Core adjusting range	80 - 150 mm
Coil weight	max. 8 kg
Weight	approx. 8,6 kg
Colour plate / base	RAL 7035 light grey, RAL 7005 mouse grey

With a brake fitted on the shelf, allowing the mounting of MESSBOI 10 H

Technical data	MATBOI 300 T
Part No.	85100157
Plate Ø	300 mm
Coil Ø	max. 290 mm
Height centering pins	110 mm
Core adjusting range	90 - 180 mm
Coil weight	max. 10 kg
Weight	approx. 9,2 kg
Colour plate / base	RAL 7035 light grey, RAL 7005 mouse grey

With a brake fitted on the shelf, allowing the mounting of MESSBOI 10 H

Coil storing units - horizontal



Fig. 7: MATBOI 450 T

Technical data	MATBOI 450 T
Part No.	85100159
Plate Ø	450 mm
Coil Ø	max. 440 mm
Height centering pins	110 mm
Core adjusting range	150 - 250 mm
Coil weight	max. 12 kg
Weight	approx. 10,2 Kg
Colour plate / base	RAL 7035 light grey, RAL 7005 mouse grey

With a brake fitted on the shelf, allowing the mounting of MESSBOI 10 H.

Length measuring devices



Fig. 8: MESSBOI 10 H

Technical data	MESSBOI 10 H
Part No.	85100203
Measuring range	1 - 15 mm
Measuring force	spring pressure
L x W x H	approx. 260 x 110 x 140 mm
Display of counter	9999,99 m
Error limit	+ / - 2 %
Colour	black / white

With holder to attach to the unwind unit.



Abb. 9: MESSBOI 25

Technical data	MESSBOI 25*
Part No.	85101000
Measuring range	2 - 25 mm
Measuring force	spring pressure
L x W x H	approx. 120 x 160 x 350 mm
Display of counter	9999,99 m
Error limit	+ / - 0,5 %
Colour	aluminum / silver
Weight	approx. 1,4 kg

*MESSBOI 25: Available with conformity assessment (formerly first calibration).

Accessories



Abb. 10: Holder for MESSBOI 25 at MATBOI storage rack

Technical data	Holder for MESSBOI 25 at MATBOI storage rack
Part No.	85101002
Colour	RAL 7005 mouse grey

Coil storing units- horizontal



Fig. 11: MATBOI 450 T



Fig. 12: MATBOI 650 T right

Technical data	MATBOI 480 T left	MATBOI 480 T right
Part No.	85101502	85101503
Type of swivel arm	left	right
Plate-Ø	480 mm	480 mm
Coil-Ø	max. 470 mm	max. 470 mm
Height centering pins	250 mm	250 mm
Core adjusting range	140 - 320 mm	140 - 320 mm
Coil weight	max. 20 kg	max. 20 kg
Colour plate / swivel arm	RAL 7005 mouse grey / zinc plated	RAL 7005 mouse grey / zinc plated

Storing unit for bigger coils mounted on swivel arm incl. brake infinitely adjustable clamping bolts.

Technical data	MATBOI 650 T left	MATBOI 650 T right
Part No.	85101505	85101506
Type of swivel arm	left	right
Plate-Ø	650 mm	650 mm
Coil-Ø	max. 640 mm	max. 640 mm
Height centering pins	250 mm	250 mm
Core adjusting range	180 - 500 mm	180 - 500 mm
Coil weight	max. 20 kg	max. 20 kg
Colour plate / swivel arm	RAL 7005 mouse grey / zinc plated	RAL 7005 mouse grey / zinc plated

Storing unit for bigger coils mounted on swivel arm incl. brake infinitely adjustable clamping bolts.

Bouncing protection

- Border pins and cover plate to avoid the bounce of the coil (e.g. for tubes and plastic pipes)

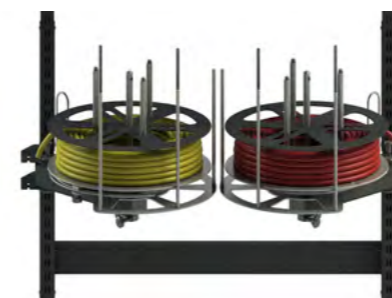

Fig. 13: MATBOI 480 T left / 480 T right with bouncing protection both sides

Technical data	Bouncing protection for MATBOI 480 T
Part No.	85101504
Cover plate Ø	max. 480 mm
Incl. 5 border pins	✓
Height border pins	305 mm
Coil height	max. 230 mm
Total weight	approx. 7,3 kg
Weight cover plate	approx. 2,7 kg
Colour cover plate	RAL 7005 mouse grey
Colour border pins	galvanised



Fig. 14: MATBOI 650 T right with bouncing protection

Technical data	Bouncing protection for MATBOI 650 T
Part No.	85101507
Cover plate Ø	max. 650 mm
Incl. 5 border pins	✓
Height border pins	305 mm
Coil height	max. 230 mm
Total weight	approx. 10 kg
Weight cover plate	approx. 3,8 kg
Colour cover plate	RAL 7005 mouse grey
Colour border pins	galvanised

Indoor use only.
Fig. may differ from original.
Technical modifications reserved.

Time-saving storage and unwinding of spools

Do you want to store spools and coils?
No Problem - A combination is possible.

» Find more information at MATBOI storage system

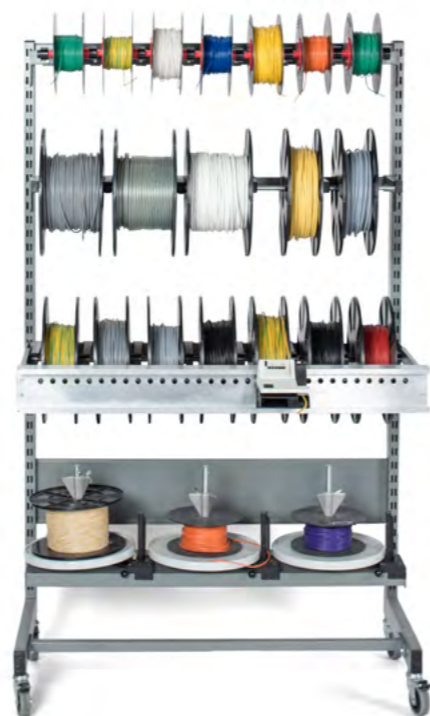

Fig. 1 SPULBOI complete device

SPULBOI

Storage rack and unwinding system for spools

Functionality:

The SPULBOI storing system is mainly used in work shops, shops or production areas. It allows clearly ordered storing, twisting-free material unwind from the spools and cutting-to-length according to demand. The special advantage of some of these racks is the individual storing of each spool which allows quick and comfortable exchange of the single spools. Due to the individual suspension each spool is slightly braked and the spool stops immediately upon material payout in order to avoid uncontrolled reeling-off after dispensing.

- Variable equipping possibilities
- Space-saving system
- Mobile storage device
- Length measurement possible
- Easy assembly and removal of the spools (spools are stored separately)
- Possible combinations with MATBOI storage rack for coils

Complete device



Fig. 2 SPULBOI complete device

Complete device	SPULBOI
Part No.	85100680
consisting of:	
1 pc storage rack 650 mobile	85101500
1 pc SPULBOI 300-3-S	86003011
1 pc SPULBOI 310-7-S	85100568
1 pc SPULBOI 310-5-S	86003099
1 pc SPULBOI 200-7-S	85100559
1 pc cable guiding rail	85100552
1 pc MESSBOI 10 LS	85100441
Technical data	
H x W x D	approx. 1780 x 1040 x 700 mm
Colour	RAL 7005 mouse grey
Weight	approx. 100 kg

Storage rack / Wall profile rail



Fig. 3 storage rack 650

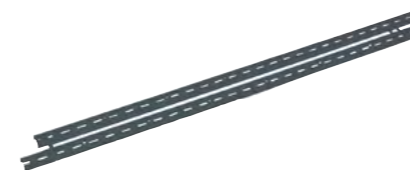

Fig. 4 Wall profile rail

Spool storing units - horizontal



Fig. 5 SPULBOI 200-4-S



Fig. 6 SPULBOI 300-3-S



Fig. 7 SPULBOI 450-2-S

Technical data	Storage rack 650 mobile	Attachment piece for storage rack
Part No.	85101500	86181001
H x W x D	approx. 1780 x 1040 x 700 mm	approx. 60 x 30 x 13 mm
Loading capacity	max. 200 kg	
Weight	approx. 46 kg	Complete unit incl. clamping rail and screws to extend storage rack about 300 mm
Colour	RAL 7005 mouse grey	
Mobile	incl. 4 breakable rollers	

Technical data	Wall profile rail (pair)
Part No.	85100201
H x W x T	approx. 980 x 30 x 13 mm
Weight	approx. 1 kg
Colour	RAL 7005 mouse grey
For mounting spool and coil storing units	

Technical data	SPULBOI 200-4-S
Part No.	86003004
Bearing	4 single mounted plates
Plate Ø	200 mm
Spulen-Ø	max. 190 mm
Axle-Ø	16 x 200 mm
Centering cone for bore Ø	25 - 80 mm
Spool weight	max. 8 kg
Colour plate / base	RAL 7035 light grey, RAL 7005 mouse grey
With overrun brake and fixture for MESSBOI 10 H mounted on shelf	

Technical data	SPULBOI 300-3-S
Part No.	86003011
Bearing	3 single mounted plates
Plate Ø	300 mm
Spool Ø	max. 290 mm
Axle-Ø	16 x 200 mm
Centering cone for bore Ø	25 - 80 mm
Spool weight	max. 8 kg
Colour plate / base	RAL 7035 light grey, RAL 7005 mouse grey
With overrun brake mounted on the shelf and slot-in storage box for MESSBOI 10 H	

Technical data	SPULBOI 450-2-S
Part No.	86003010
Bearing	2 single mounted plates
Plate Ø	450 mm
Spool Ø	max. 440 mm
Axle-Ø	16 x 200 mm
Centering cone for bore Ø	25 - 80 mm
Spool weight	max. 8 kg
Colour plate / base	RAL 7035 light grey, RAL 7005 mouse grey
With overrun brake mounted on the shelf and slot-in storage box for MESSBOI 10 H	

SPULBOI

Storage system for spools

Spool storing units- vertical



Fig. 8 SPULBOI 200-7-S

Technical data	SPULBOI 200-7-S
Part No.	85100559
Bearing	Patent holders for 7 single mounted spools
Spool Ø	150 - 200 mm
Spool width	75 - 80 mm
Spool bore	Ø 18,5 mm
Spool weight	max. 4 kg
Colour	RAL 7005 mouse grey
With patented axle-free spool holders. Spools (Part No. 85015850, 8501584) are suspended and removable individually.	



Fig. 9 SPULBOI 310-7-S

Technical data	SPULBOI 310-7-S
Part No.	85100568
Bearing	Patent holders with 7 single mounted spools
Spool Ø	310 mm
Spool width	75 mm
Spool bore	Ø 18,5 mm
Spool weight	max. 5 kg
Colour	RAL 7005 mouse grey
With patented axle-free spool holders. Spools (Part No. 85100404) are suspended and removable individually and included in the scope of delivery.	



Fig. 10 SPULBOI 310-5-S

Technical data	SPULBOI 310-3-S	SPULBOI 310-4-S	SPULBOI 310-5-S
Part No.	86004080	86003098	86003099
Bearing	3 individually stored axles	4 individually stored axles	5 individually stored axles
Spool-Ø	max. 310 mm	max. 310 mm	max. 310 mm
Spool width	max. 270 mm	max. 215 mm	max. 167 mm
Axle-Ø	10 mm	10 mm	10 mm
Spool weight	max. 20 kg	max. 15 kg	max. 10 kg
Total loading capacity	max. 50 kg	max. 50 kg	max. 50 kg
Colour	RAL 7005 mouse grey	RAL 7005 mouse grey	RAL 7005 mouse grey

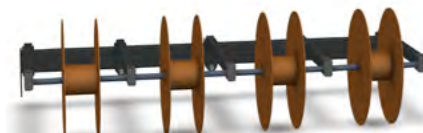

Fig. 11 SPULBOI 500-4-S

Technical data	SPULBOI 500-4-S
Part No.	86103090
Bearing	4 individually stored axles
Spool-Ø	max. 500 mm
Spool width	max. 215 mm
Axle-Ø	10 mm
Spool weight	max. 8 kg
Total loading capacity	max. 30 kg
Colour	RAL 7005 mouse grey

SPULBOI

Storage system for spools

Empty spools



Fig. 12 Spool
Part No. 85015840



Fig. 13 Spool
Part No. 85100404

Cable guiding rail & Length measuring devices



Fig. 14 Cable guiding rail



Fig. 15 MESSBOI 10 LS

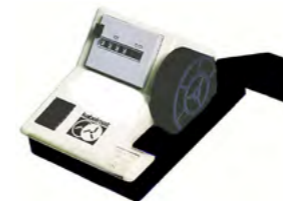

Fig. 16 MESSBOI 10 H

Spool storage rack - Table version

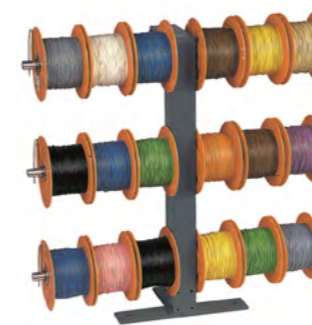

Fig. 16 SPULBOI 200

Technical data	Empty spool	Empty Spool	Empty Spool	Empty Spool
Part No.	85015850	85015840	85100404	85100406
Spool-Ø	150 mm	200 mm	310 mm	310 mm
Core-Ø	50 mm	50 mm	150 mm	150 mm
Spool width	80 mm	75 mm	75 mm	150 mm
Bore-Ø	18,5 mm	18,5 mm	30 mm	30 mm
Loading capacity	max. 4 kg	max. 4 kg	max. 5 kg	max. 5 kg
Colour	orange	black	black	black

Technical data	Cable guiding rail
Part No.	85100552
Equipped with 30 reverse-lock wire guides. The rail includes horizontal extension slides and can be mounted to rack or wall profile to centralize material dispensing. For spools up to Ø of 310 mm.	

Technical data	MESSBOI 10 LS	MESSBOI 10 H
Part No.	85100441	85100203
Material-Ø	1 - 15 mm	1 - 15 mm
Measuring force	Spring pressure	Spring pressure
L x W x H	approx. 260 x 110 x 140 mm	approx. 260 x 110 x 140 mm
Display of counter	9999,99 m	9999,99 m
Measuring accuracy*	+ / - 2 %	+ / - 2 %
Colour	black / white	black / white
Cable guiding track necessary	✓	-

Holder	With holder for mounting into cable guiding rail. Length measuring unit can be moved along the rail.	With holder to attach to the unwind unit.
--------	--	---

Technical data	SPULBOI 200
Part No.	85001620
Amount of spools	max. 18
Spool-Ø	max. 200 mm
Spool width	max. 80 mm
Axle Ø	18 mm
Weight	approx. 5.5 kg
Material	steel
Useable axle length	6 x 260 mm
L x W x H	approx. 620 x 165 x 620 mm
Colour	RAL 7005 mouse grey

Empty spools are not included in the scope of delivery.

Strong helper with various equipping possibilities

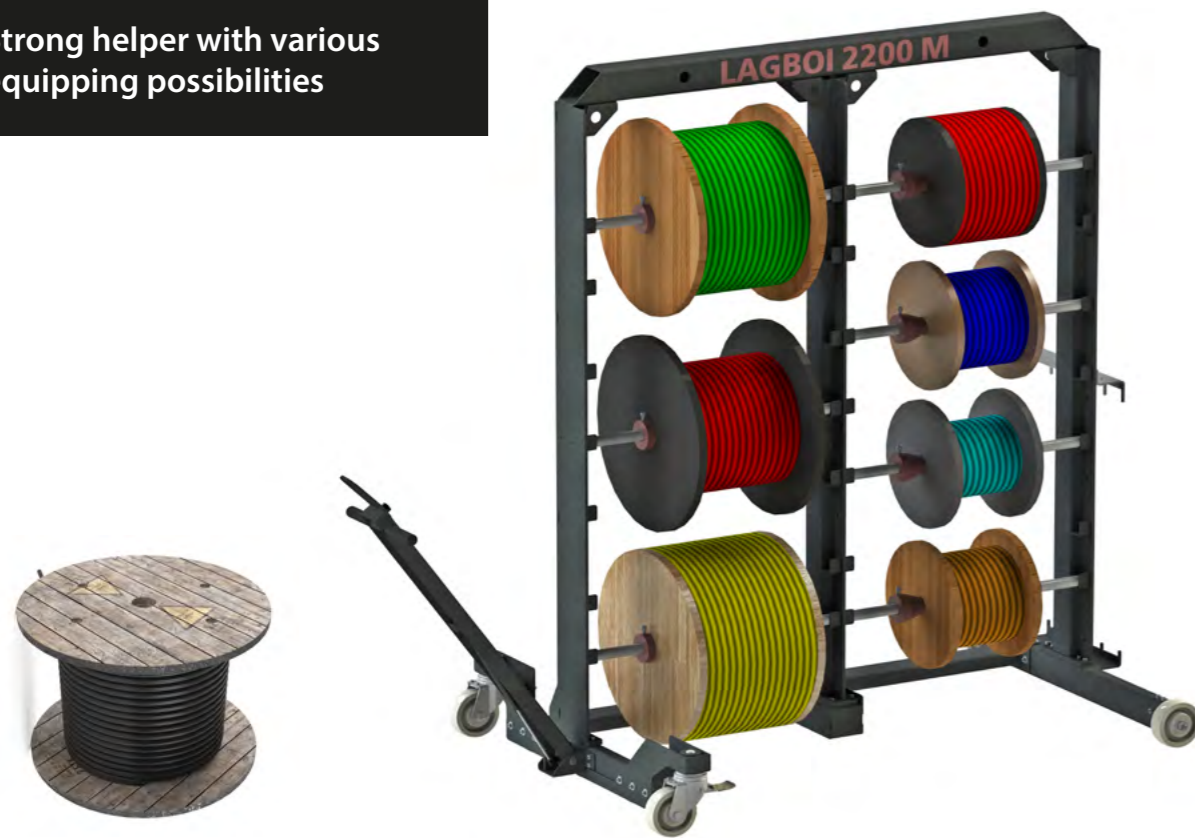

Fig. 1: LAGBOI 2200 M

LAGBOI 2200 / 3000

- Drum rack and unwinding system in stationary or mobile version

Functionality:

The **LAGBOI** consists of pre-assembled modules (frame and crossbars) and can be assembled to a solid, clearly ordered, space-saving and very useful rack and unwinding device. The system is only suitable for **manual unwinding**.

- Variable equipping possibilities
- High stability
- High surface protection (powder coated)
- Available in stationary or mobile version
- Travelling equipment / drawbar includes a gas pressure spring (compensated weight)

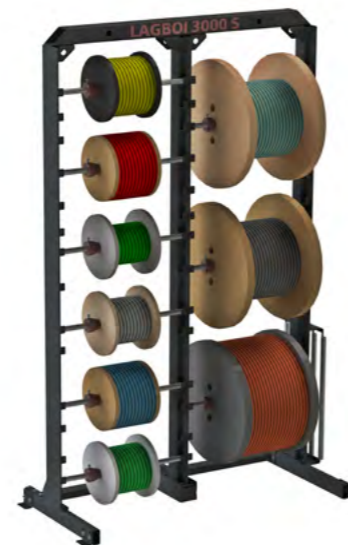

Fig. 2: LAGBOI 3000 S

Base frame

Technical data	LAGBOI 3000 S	LAGBOI 2200 S	LAGBOI 3000 M	LAGBOI 2200 M
Part No.	85100934	85100935	85100936	85100937
H x W x D	3080 x 2000 x 980 mm	2170 x 2000 x 980 mm	3110 x 2000 x 1200 mm	2200 x 2000 x 1200 mm
Loading capacity	max. 3000 kg	max. 3000 kg	max. 2200 kg	max. 2200 kg
Weight	approx. 250 kg	approx. 200 kg	approx. 280 kg	approx. 230 kg
Colour	RAL 7005 mouse grey	RAL 7005 mouse grey	RAL 7005 mouse grey	RAL 7005 mouse grey
Travelling equipment with drawbar and 4 heavy-duty-wheels	X	X	✓	✓

Equipping possibilities depending on drum sizes (KTG design DIN 46391)

Equipping possibility depending on drum size	LAGBOI 3000 S	LAGBOI 2200 S	LAGBOI 3000 M	LAGBOI 2200 M
	12 x Ø 400 mm drums 2 x 6 axles	8 x Ø 300 mm drums 2 x 4 axles	12 x Ø 400 mm drums 2 x 6 axles	8 x Ø 300 mm drums 2 x 4 axles
or	8 x Ø 600 mm drums 2 x 4 axles	6 x Ø 600 mm drums 2 x 3 axles	8 x Ø 600 mm drums 2 x 4 axles	6 x Ø 600 mm drums 2 x 3 axles
or	6 x Ø 800 mm drums 2 x 3 axles	4 x Ø 900 mm drums 2 x 2 axles	6 x Ø 800 mm drums 2 x 3 axles	4 x Ø 900 mm drums 2 x 2 axles
or	4 x Ø 1000 mm drums 2 x 2 axles		4 x Ø 1000 mm drums 2 x 2 axles	

Drum axle

Part No.	Description
85008010	Drum axle no. 1 Ø 34 x 840 mm incl. centering cones with locking screws

Recommended accessory:

- **TROMSTOP transport and loading accessory** to transport, store and remove drums in and out of a drum rack



Fig. 3: Drum axle incl. centering cones

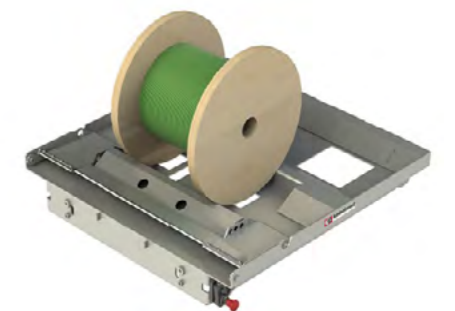

Fig. 4: TROMSTOP transport and loading accessory

Note: The device LAGBOI has to be assembled on site in accordance with the delivered manual. The assembly is not included in the supply.

Indoor use only.
Fig. may differ from original.
Technical modifications reserved.

Based on your individual demand

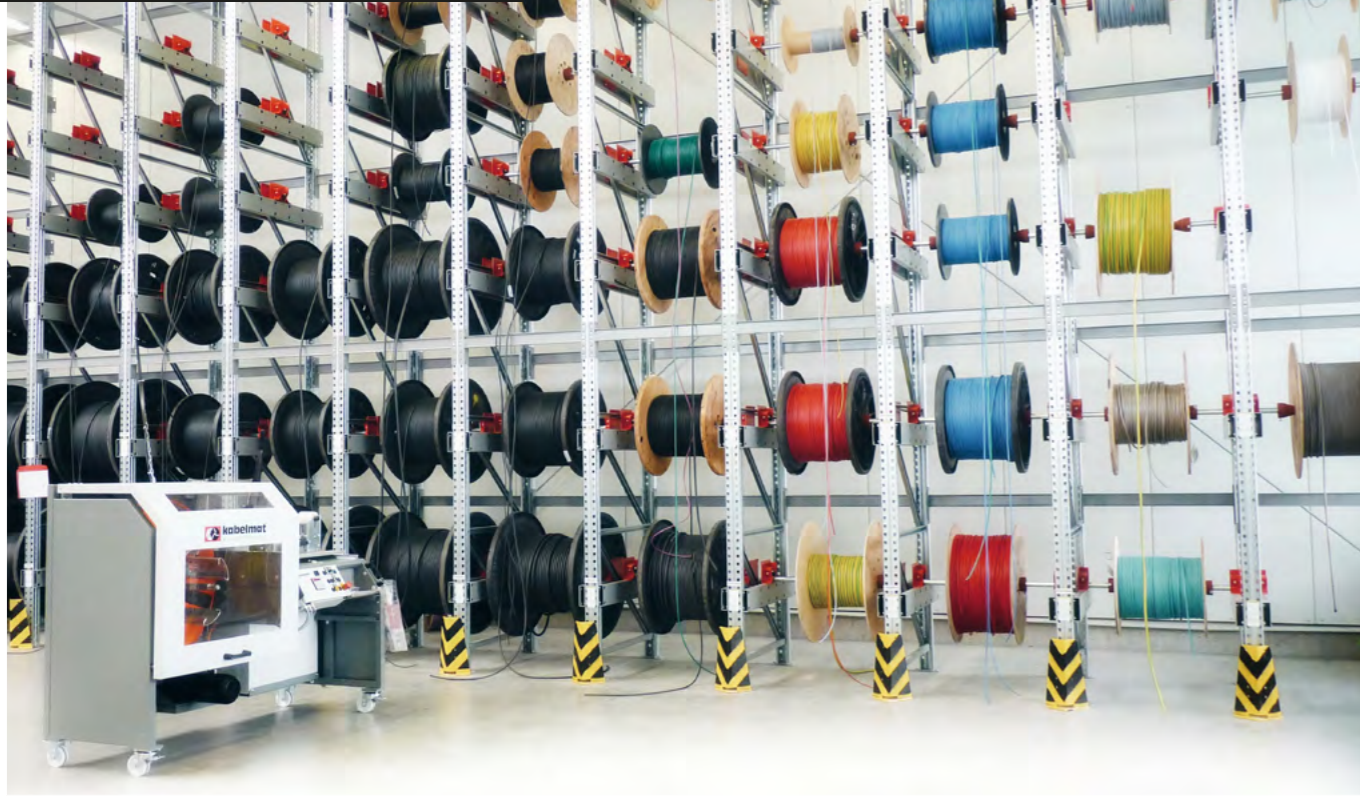

Fig.1 LAGROL drum rack with MOTROL 800 EASY coil and spool winding machine

LAGROL

- Drum rack and unwinding system

Functionality:

The LAGROL drum rack segments consist of two frames each of appropriate height, the necessary cross connectors for the respective segment load as well as of the axle holding fixtures and the axles for the drums. For each further segment only an additional frame is required and the corresponding number of cross connectors, axle holding fixtures and axles. The system is suitable for manual and motorized winding.

This drum rack and unwinding system is ideal for the use in a production line along with the motorized take-ups such as UMROL, MOTROL or AUTOCUT. The solid construction with special and patented axle and / or drum holders and the fact that winders and storage system are well-suited to each other make this system ideal for the above mentioned range of application.

- Variable equipping possibilities
- Customer-specific system
- High stability
- High surface protection (powder coated)
- Perfect addition to winders
- Suitable for motorized winding



Fig.2 LAGROL axle holder

Fig.3 LAGROL drum rack with TROMPLAT transport and loading tool for drums

Also suitable for motorized winding

Store and wind winding materials comfortable - The perfect combination

- MOTROL 800 EASY coil and spool winding machine

The MOTROL 800 Easy is the entry-level model in the machine sector. This motorized ring and drum winding machine is designed for winding coilable material such as cables, pipes, hoses, steel ropes, plastic profiles etc. either as rings or on spools and drums. With the appropriate components such as length measuring device and material cutter, the material can be measured and cut to length. The winding speed is adjustable at the operating desk by means of a rotary potentiometer. The frequency-controlled winding drive allows a smooth winding of the material.

Our unwinders of the type MOTROL or UMROL allow unwinding straight from the stored drums. This is possible due to the solid design as well as to the patented axle holding fixtures with exchangeable brake linings.

» Find more information at MOTROL 800 EASY



Fig.4 MOTROL 800 EASY Coil and spool winding machine

Frames and crossbars

Part No.	Frames
85300073	Height 2200 mm
85300074	Height 2500 mm
85300075	Height 2700 mm
85300076	Height 3000 mm
85300077	Height 3300 mm
85300078	Height 3600 mm
85300079	Height 3800 mm
85300080	Height 4100 mm
85300081	Height 4400 mm
85300082	Height 4700 mm
85300083	Height 5200 mm
85300084	Height 5500 mm
85300085	Height 5800 mm
85300086	Height 6000 mm

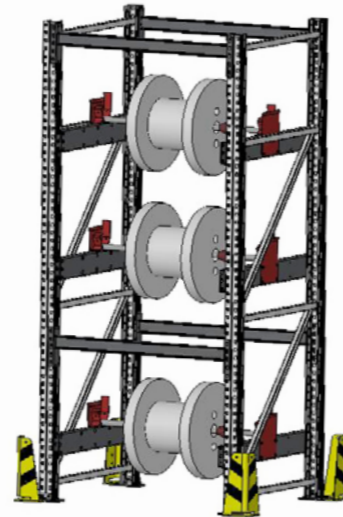

Fig.5 Example drum rack with 1 field

Part No.	Crossbars	Necessary crossbars	Loading capacity
85300090	870 mm up to Ø 900 mm	Height 2200 mm 1 front, 1 back	max. 3000 kg
85300091	1170 mm up to Ø 1400 mm	Height 2500 - 4100 mm 2 front, 2 back	max. 3000 kg
85300092	1370 mm up to Ø 1600 mm	Height 4400 - 5200 mm 3 front, 3 back	max. 4000 kg
85300093	1570 mm up to Ø 2000 mm	Height 5500 - 6000 mm 4 front, 4 back	max. 5200 kg

Frame accessory

Part No.	Accessory
85300097	Floor anchors (4 pcs. per frame)
85300099	Collision guard, corner (2 pcs. per frame)
85300098	Collision guard, front for drum Ø 900mm
85300115	Collision guard, front for drum Ø 800mm



Fig.6 Collision guard, corner



Fig.7 Collision guard, front

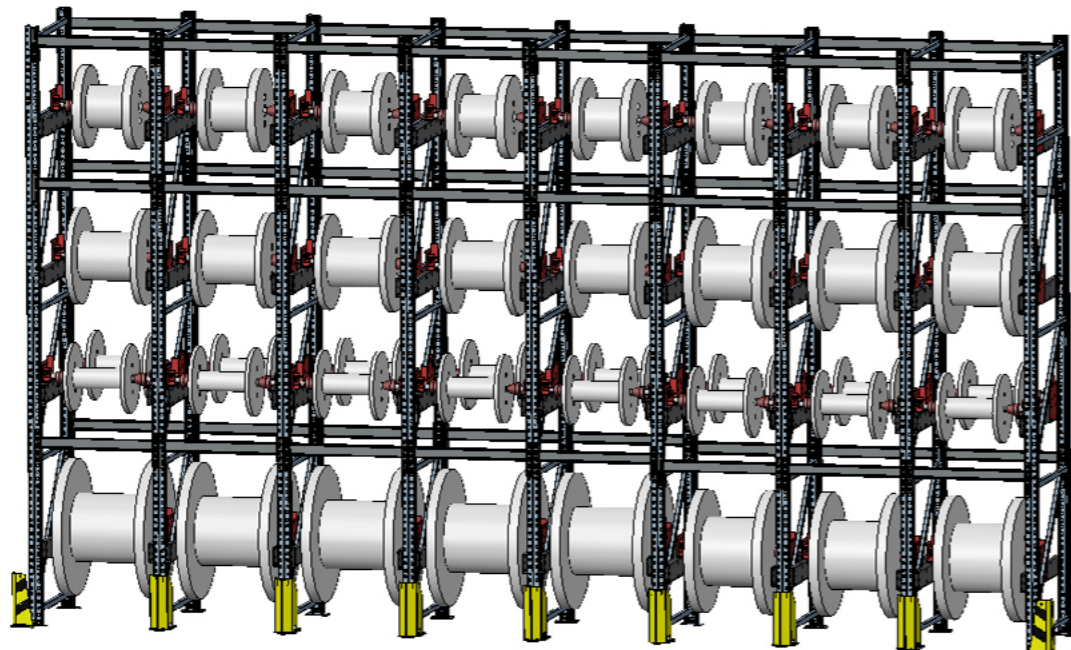

Fig.8 Example drum rack with 8 fields

Axle holders / shells

Part No.	Pair of axle holders with retaining tubes excl. brake pads
85300100	LAGROL 1050 mm depth, 2000 kg incl. retaining tubes - 3 holding pos. for single drum allocation
85300105	LAGROL 1050 mm depth, 2000 kg incl. retaining tubes - 5 holding pos. for double drum allocation max. drum Ø600mm

Part No.	Pair of axle holders with retaining tubes incl. brake pads
85300101	LAGROL 1050 mm depth, 2000 kg incl. retaining tubes - 3 holding pos. for single drum allocation

Part No.	Pair of axle shells excl. brake pads
85300104	LAGROL pair of axle shells without retaining tubes excl. brake pads

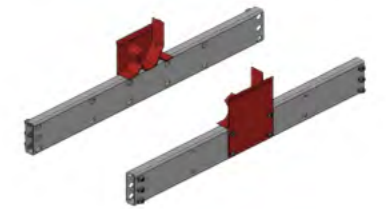

Fig.9 Pair of axle holders with retaining tubes excl. brake pads (3 pos.) for single drum allocation



Fig.10 Pair of axle shells excl. brake pads



Fig.11 Axle shell incl. brake pad for Ø60 mm axle drum



Fig.12 Brake pads for axle drum Ø34 mm



Fig.13 Brake pad for axle drum Ø60 mm

Brake pads for axle holders / shells

Part No.	Brake pads for axle holders / shells
85300103	Brake pads (2 left, 2 right) when using drum axle Ø 34mm
85300113	Brake pads (1 left, 1 right) when using drum axle Ø 60mm

Drum axle incl. 2 centering cones

Part No.	Drum axle incl. 2 centering cones
85008010	Ø 34 - 840 mm, Loading capacity 1000 kg
85008020	Ø 34 - 1140 mm, Loading capacity 700 kg
85008030	Ø 60 - 1140 mm, Loading capacity 1700 kg
85008040	Ø 60 - 1340 mm, Loading capacity 2000 kg

Special axes upon request



Fig.14 Drum axle incl. 2 cones

Clamping tool for cones

Part No.	Clamping tool for cones
85300108	Clamping tool for cones with axle Ø 34 mm
85300109	Clamping tool for cones with axle Ø 60 mm



Fig.15 Clamping tools for cones

Drum axle incl. driving pin

Part No.	Drum axle incl. driving pin
85300114	Ø 60 - 1140 mm, Loading capacity 2000 kg
85300110	Ø 60 - 1340 mm, Loading capacity 2000 kg

Indoor use only. Fig. may differ from original.



Fig.16 Drum axle incl. driving pin

Cable trailing system for LAGROL

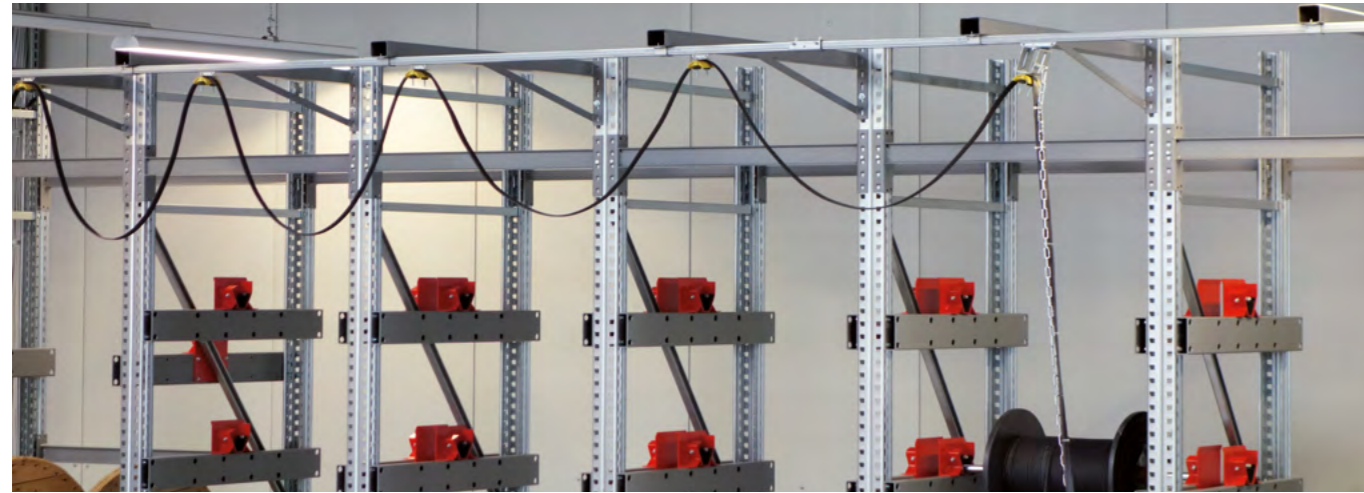

Fig.17 Cable trailing system for rack mounting

- Cable trailing system with flat cable for rack mounting / ceiling mounting 230V/400V / 16A

Functionality:

The components of the cable trailing system are made of galvanized steel. The ball-bearing rollers assure smooth and trouble-free running in a special profile rail. The cables are gently clamped by neoprene rubber plates. A specially shaped pressure-reducing piece prevents the cable from getting kinked at the clamping point. The system is mounted on the associated carrying arms on Kabelmat drum rack and unwinding system LAGROL.

Basic equipment:

- U-profile rail with holder for rack mounting
- Cable trolley with clamping device for flat cables
- Buffer for cable carrier left / right
- Discharging terminal
- Stopper
- Terminal box for wall mounting to connect main supply
- Flat cable with plug to supply the machine with power

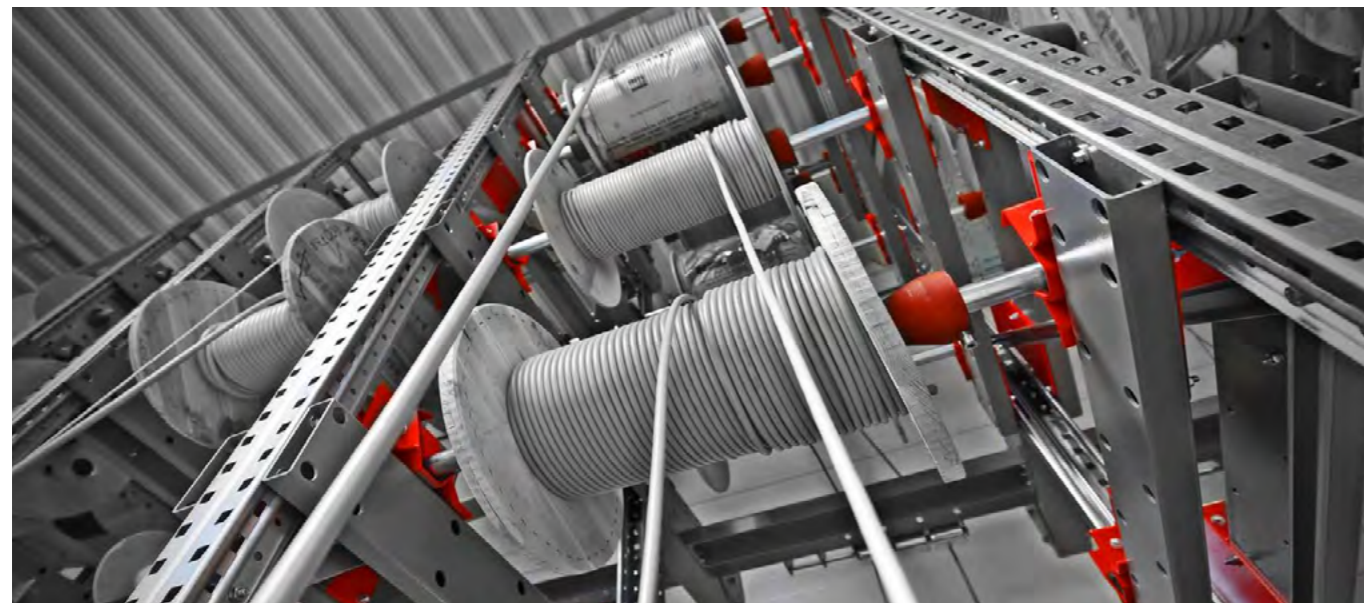

Fig. 18 LAGROL drum rack

Heavy-load drum rack



Fig. 1 ABROL heavy-load drum rack combined with LAGROL drum rack

ABROL

- Heavy-load drum rack and unwinding system for big drums up to 5000 kg

Functionality:

The heavy-load drum rack and unwinding system ABROL are designed for feeding material to a Kabelma winding and cutting machine. The system can be used as single feeding system as well as with additional attachable units. The drum is carried by means of a consistent axle which is centered by two cylindrical cones. The holders for the axles are equipped with brake linings for a more quiet unwinding from a drum and a reduced run after of the material.

Technical data	ABROL
Part No.	1025.000
Drum-Ø	400 - 2200 mm
Drum weight	max. 5000 kg
Drum width	max. 1450 mm
Base unit H x W x D	approx. 3200 x 2320 x 2140 mm
Extension unit H x W x D	approx. 3200 x 2160 x 2140 mm

Indoor use only. Fig. may differ from original.

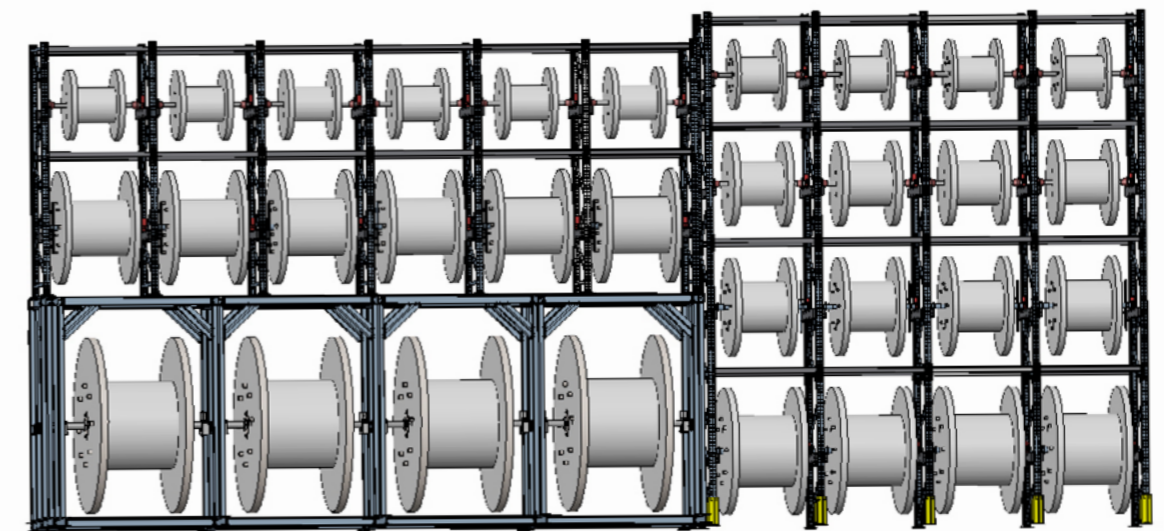

Fig. 2 Model of ABROL heavy-load drum rack combined with LAGROL drum rack

TROMSTOP

Transport and loading tool for highlift truck

For the transport with a lifting device

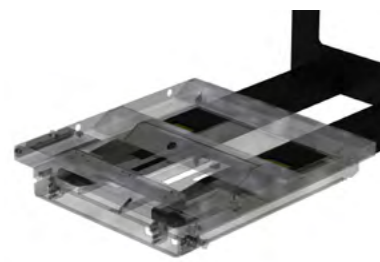

Fig. 1 TROMSTOP, example of use



Fig. 2 TROMSTOP, loading ramp fold out

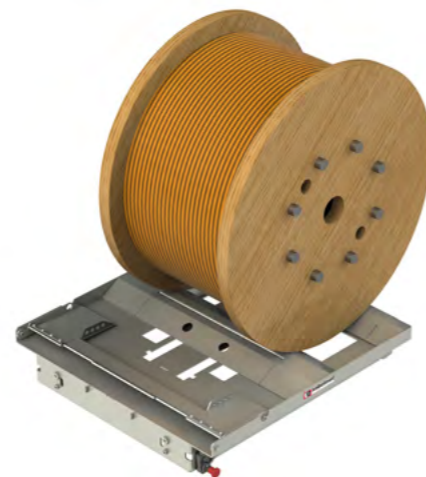

Fig. 3 TROMSTOP with drum Ø800 mm (sample)

TROMSTOP

- Transport and loading tool for transporting drums via highlift truck

Functionality:

The tines of the lifting equipment are driven in beneath the placement platform. As soon as the tines have reached the end of the platform, a locking pin closes beneath the platform - the platform is thereby firmly secured. The drums to be transported can now be rolled on via fold-out loading ramps. Predefined centring mechanisms ensure stable mooring of the drums, which corresponds with the load centre of the lifting equipment. Once the drums have been rolled on, the width-adjustable loading ramps are folded in and transportation can begin.

- Time-saving and safe transport of drums
- Easy storage and removal of drums in and out of a drum storage
- Suitable for almost all lifting devices

Technical data	TROMSTOP
Part No.	87000313
Drum-Ø	400 - 1000 mm
Drum width	max. 710 mm
Drum weight	max. 900 kg
L x W x H	788 x 780 x 135 mm
Weight	approx. 45 kg
Material	zinc-plated
Lifting equipment requirements (fork tines)	
Fork tine format	open
Fork outside spacing	min. 540 - max. 580 mm
Fork tine height (lowered)	max. 85 mm
Fork tine length	approx. 1150 mm
Fork tine width	170 - 185 mm
Load center distance for drum-Ø 710 - 1000 mm (weight max. 900 kg) for drum-Ø 400 - 630 mm (weight max. 250 kg)	approx. 600 mm approx. 890 mm
Tine thickness at the fork tine tip	max. 35 mm
Sheet thickness at the fork tine tip	max. 6 mm

TROMPLAT 1000 / 2500

Transport and loading tool for forklift truck

For the transport with a forklift truck



Fig. 1 TROMPLAT 1000

TROMPLAT 1000 / 2500

- Transport and loading tool for transporting drums via forklift truck

Functionality:

This transport and loading accessory consists of two plat forms (extensions) which are put on the forks and fixed by safety bolt. By changing these accessories from the right to the left and vice versa they can either be used for small drums as well as for bigger ones. The drum is simply rolled away on the floor. To avoid that the drum falls out, it must rest in centering position. Perfect for forklifts with hydraulically adjustable forks.

- Time-saving and safe transport of drums
- Easy storage and removal of drums in and out of a drum storage
- CE marking

Technical data	TROMPLAT 1000	TROMPLAT 2500
Part No.	87000310	87000311
Length	depending on length of the fork tines	depending on length of the fork tines
Loading weight	max. 1000 kg	max. 2500 kg
Weight	60 kg / pair	150 kg / pair
Colour	RAL 7005 mouse grey	RAL 7005 mouse grey



Fig. 2 TROMPLAT 1000 example of storing the drum into a Kabelmat LAGROL rack



Fig. 3 TROMPLAT 1000 example of use

SPULROLLY

Spool storage and unwinding device

Spool storage device with central material outlet



Fig. 1 SPULROLLY example for arrangement with split pair coils

SPULROLLY

- Multifunctional spool storage and unwinding device

Functionality:

Spool storage and unwinding device made of aluminium profiles which accepts different spools. Brake unit consisting of brake disk with adjustable pendulum for opening and closing the rope brake. Tension force of the pendulum is adjustable at the tension spring. The winding axle is made of hardened steel shaft. Through-feed cage with rewind stop.

- Central sampling point for all cables
- Adjustable break mechanism to avoid an uncontrolled material flow
- Space-saving solution
- Double-sided component assembly possible

Technical data	SPULROLLY
Part No.	1749.000
Amount of spool units	selectable, pairs of spools are always arranged at the basic opposite
Spool Ø	max. 450 mm
Spool width for bore Ø 25	max. 200 mm
Spool width for bore Ø 65	max. 280 mm
Spool weight	max. 20 kg
Arrangement of the spools	on request

Indoor use only. Fig. may differ from original.
Technical modifications reserved. Status 01/2020



Fig. 2 SPULROLLY single unit

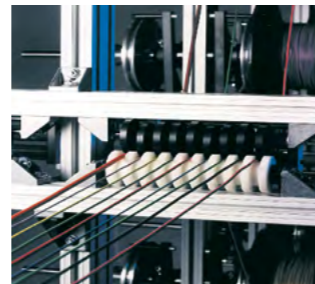

Fig. 3 SPULROLLY return stop

Indoor use only.
Fig. may differ from original.
Technical modifications reserved.

TROMBULLY

Drum storage and unwinding device

Drum storage device with central material outlet

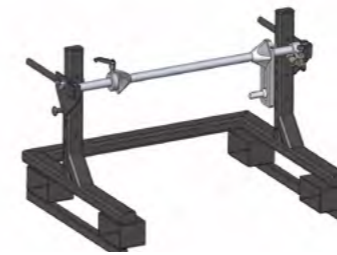

Fig. 1 TROMTRAK 1000 drum storage device



Fig. 2 TROMBULLY with central point of removal and return stop

TROMBULLY

- Multifunctional drum storage and unwinding device

Functionality:

The multifunctional TROMBULLY-system is suitable for mechanical pay-off in connection with a motor driven rewind or cutting-to-length machine. It is the ideal system for the manufacturing of cable sets, cable forms or cable looms in the machine construction and pre-assembly area. This system consists of a frame unit, the size of which can be extended individually. In this frame unit the drum storage devices TROMTRAK 1000 are installed and fixed by means of a lifting device (not included in the scope of supply). The drum storage devices TROMTRAK 1000 are equipped with the drum on the floor. The drums are slid on the axles and fixed by means of a cone and a clamping screw. An adjustable shoe-type brake avoids the follow-up movement of the drum. Once the drum storage device TROMTRAK 1000 is mounted in the frame unit, the material to be coiled is passed through the guides and at the outfeed, is pushed through the outfeed rake which serves as guide and additional return stop. The central cable guiding at the end of the frame unit allows the individual removal of the cables and lines concerned. It is also possible to remove several cables and lines at the same time.

- Central sampling point for all cables
- Adjustable break mechanism to avoid an uncontrolled material flow
- Space-saving solution
- TROMTRAK drum storage devices also usable as single devices
- Double-sided component assembly possible



Fig. 3 TROMTRAK 1000 drum storage device in use

Technical data	TROMBULLY
Part No.	1075.000
Amount of drum units	selectable
Drum Ø	max. 1000 mm
Drum width	max. 710 mm
Drum weight per unit	max. 500 kg
Arrangement of the drum units	max. 4 pcs. one upon the other / max. 15 pcs. behind each other
Material Ø	max. 20 mm

Indoor use only. Fig. may differ from original.

Indoor use only.
Fig. may differ from original.
Technical modifications reserved.

OUR PRODUCT RANGE

Get to know the complete Kabelmat product world

Due to the big variety of products, this catalogue is only an excerpt of the Kabelmat product range and does not contain all products.

Take the opportunity to find out more about our range of large machines and systems as well as the many accessory components in our product data sheets and brochures in PDF format. You will find our detailed data sheets for all Kabelmat products on our website www.kabelmat.com in the „Download Center“ section or simply send us an e-mail to kabelmat@kabelmat.com and we will be happy to send you the requested documents by e-mail.

If you are interested in our **large cable cutting systems** or in our large selection of **accessory components and articles**, please call us on Tel: 07443 9670-0 and we will send you the product information by e-mail.

Accessories

The ideal complement to your machine

- **PLACEMENT AND REMOVAL TOOL** for drums and coils
- **DRIVE** for drum winders
- **MATIS H/P** cutting devices hydraulic / pneumatic / manual
- **AUTOBIND** binding automat
- **RAPID** coiler heads



You can find the complete overview on our website www.kabelmat.com in the „Download Center“.

LET'S GET SOCIAL

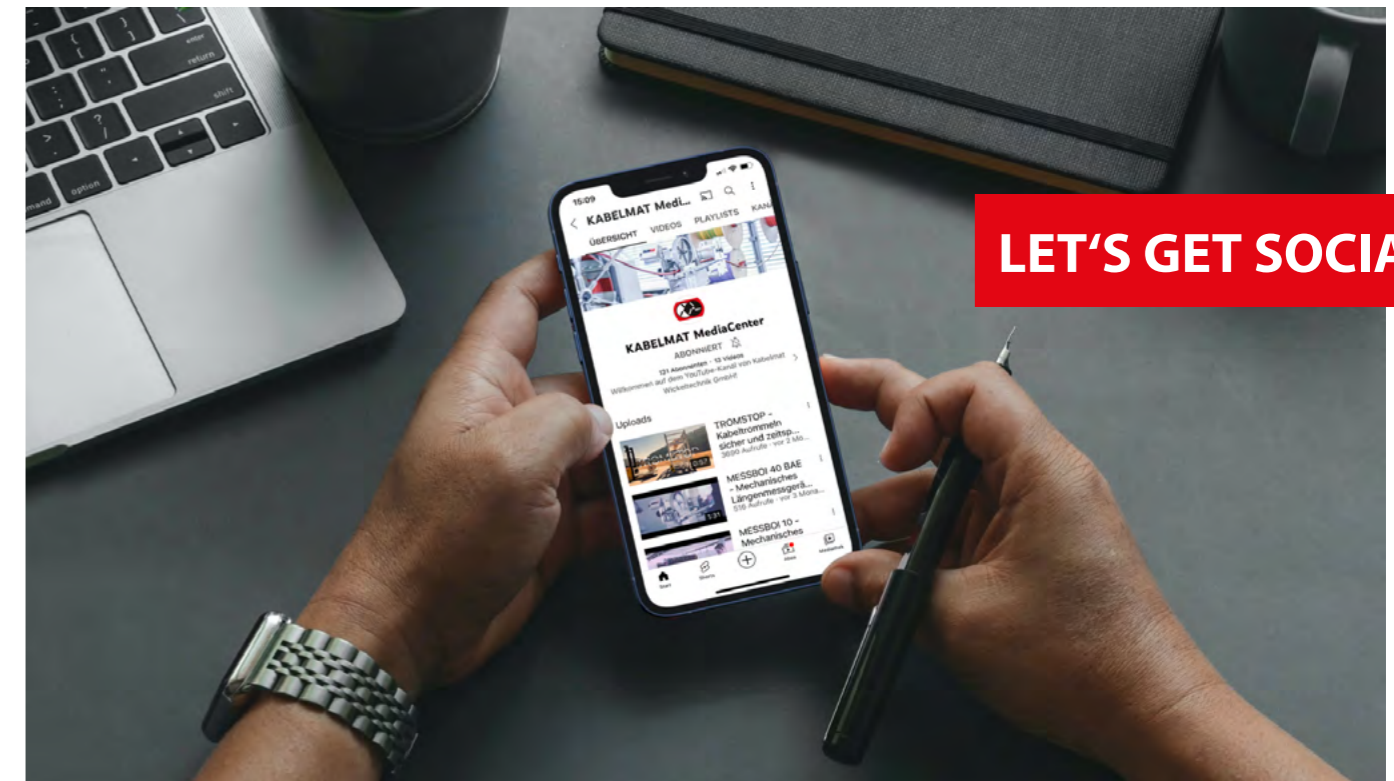

Lernen Sie Kabelmat noch besser kennen und verpassen Sie keine Neuigkeiten mehr.

Kabelmat finden Sie jetzt auch auf:

- Instagram
- Facebook
- LinkedIn
- Youtube

Redefining logistics in the cable industry

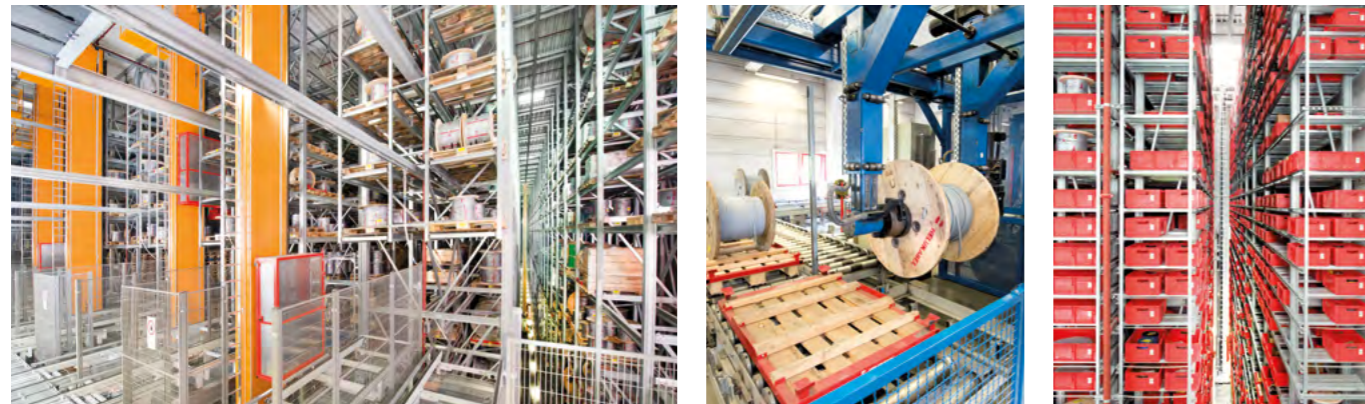

HELUKABEL® operates one of Europe's largest and most modern distribution centres for cables and wires at its headquarters in Hemmingen, Germany (near Stuttgart). There, a majority of the 33,000 items are stored in a warehouse offering more than 160,000 m² of space. Through the use of state-of-the-art conveyor and control technology, more than 1,000 orders can be picked and shipped daily to destinations around the world.

Neuenhagen/Berlin is the central warehouse location for underground and medium-voltage cables. Storage capacities of more than 5,000 m² in the warehouse and 50,000 m² outdoors enable fast deliveries to construction and major project sites. The new logistics centre at the Taicang (China) production facility serves as a product distribution hub for Asia and offers great advantages, particularly for handling extensive time- and volume-critical projects.

Facts & Figures

- 40,500 Euro-pallet bays for drums up to 1,500 kg; 16 aisles with 16 storage and retrieval devices
- 36,800 container spaces in the automatic small parts warehouse; Capacity 1,000 containers per hour
- 670 storage spaces in the heavy-load warehouse; reels up to max. 4,000 kg and 2.20 m diameter
- 2 km conveyor line for pallets
- Conveyor system connects directly to the cable-cutting machines



Cables and wires – Made in Germany

At our two German production sites, HELUKABEL® GmbH manufactures approximately one million kilometres of wire, enough to circle the earth 25 times, using the latest production methods. More than 300 qualified employees specialise in the production of high-quality standard and special-purpose cables. We drive innovation in the fields of automation, data technology, building technology, and renewable energy by using the newest materials, constantly optimising our production methods, and by collaborating with international testing institutes. Since 2014, HELUKABEL® has been manufacturing in Taicang, China, predominantly for the Asian market. As with the German plants, the focus here is also on high-quality, flexible and highly flexible cables and wires. A crucial stage in the development process of our products is the work performed in our testing centre. For example, cables suitable for drag chain applications can be tested with acceleration of up to 10 G. Temperature ranges from -50°C to +250°C are simulated in a special climate-controlled unit to enable the testing of drag chain cables for series production readiness before they are installed in applications such as refrigerated warehouses or steel mills.

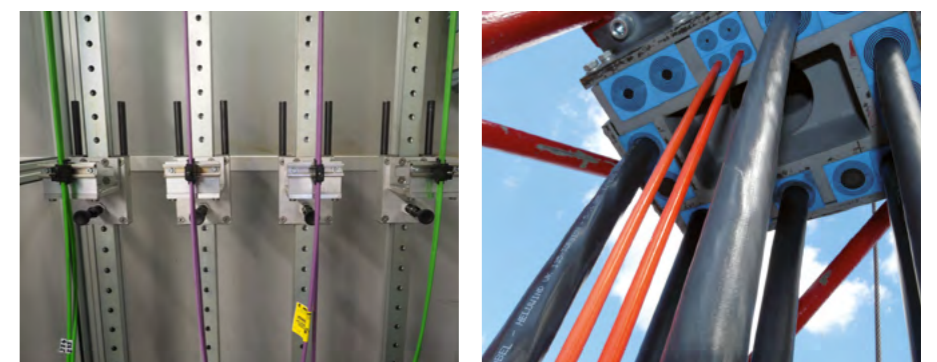
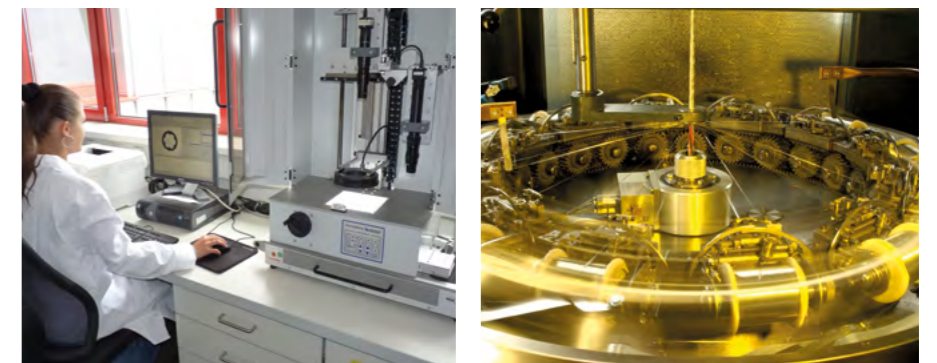

Facts & Figures

- Test facilities for bending and torsion requirements
- Drag chain testing systems
- Fire testing systems
- Abrasion testing systems
- Torsion test-tower for wind turbines
- Aging ovens in accordance with UL, CSA, VDE, HAR, TÜV, CCC

15 horizontal grey lines for writing notes.

15 horizontal grey lines for writing notes.

Blank lined area for notes.

©Kabelmat® Wickeltechnik GmbH

All information in our brochures, catalogs, and on the Internet is based on our current knowledge of the described products.

No legally binding assurance of specific properties or suitability for a particular purpose can be derived from this information.

They do not release the buyer from the obligation to conduct their own tests and trials to determine the specific suitability of the products for the intended purpose.

Kabelmat Wickeltechnik GmbH assumes no liability for damages resulting from the application of the products.

Kabelmat Wickeltechnik GmbH reserves the right to make technical changes and improvements through continuous development of products and services.

Reprinting or reproduction of texts and illustrations, even in part, is reserved.

The transfer of copyrights generally requires the written permission of Kabelmat® Wickeltechnik GmbH.

Our general terms and conditions apply, which can be viewed at www.kabelmat.com.

Technical changes as well as changes in form, color, and/or weight are reserved within reasonable limits.

As of 09/2023

We are your partner in professional winding technology.



Kabelmat Wickeltechnik GmbH

Steinbuckelweg 25

72293 Glatten (GER)

Phone +49 7443 9670 - 0

Fax +49 7443 9670 - 39

kabelmat@kabelmat.com

www.kabelmat.com



Follow us on Social Media.

