



# KABELMAT WINDING TECHNOLOGY

We deliver the **total solution.**

# Specialists for storage and processing of winding materials

Kabelmat offers a wide range of solutions for processing cables, wires, pipes, steel cables, hoses and profiles.



**Warehouse  
technology**



**Manual & machine  
winding technology**



**Machinery plants &  
lines**

**Product  
Range**

# EVERYTHING FROM ONE SOURCE

Value-added processes in the world of winding technology

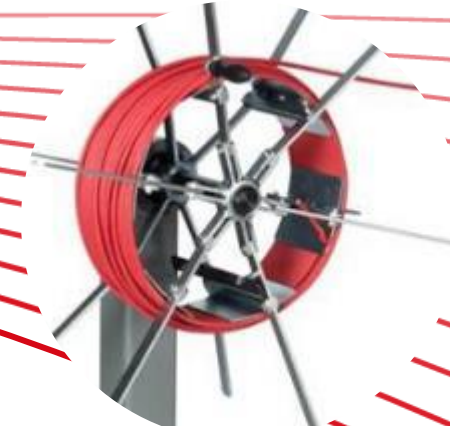
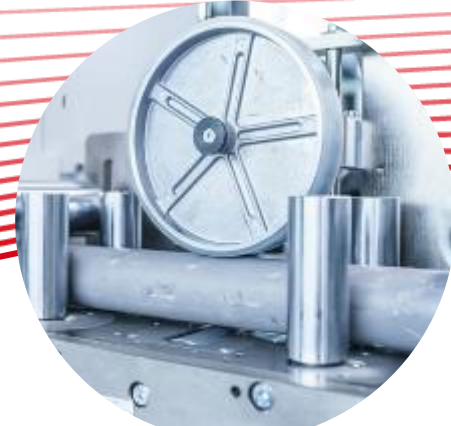
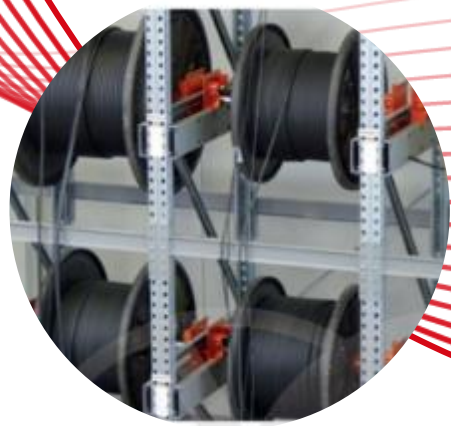

Storage

Transport

Unwinding

Length measurement

Cutting

Winding

Bind & pack

ON SITE **WORLDWIDE**

PART OF HELUKABEL GROUP



**2200**

Employees

**60**

Sales & Production Locations

**796**

Mio. € turnover  
in 2021

**39**

Represented  
in 37 countries





**OUR  
PRODUCTS**

We deliver the **total solution.**

# Before Kabelmat was there...



... after Kabelmat was there



# STORAGE TECHNOLOGY FOR ALL REQUIREMENTS

Storage technology – KABELMAT Wickeltechnik

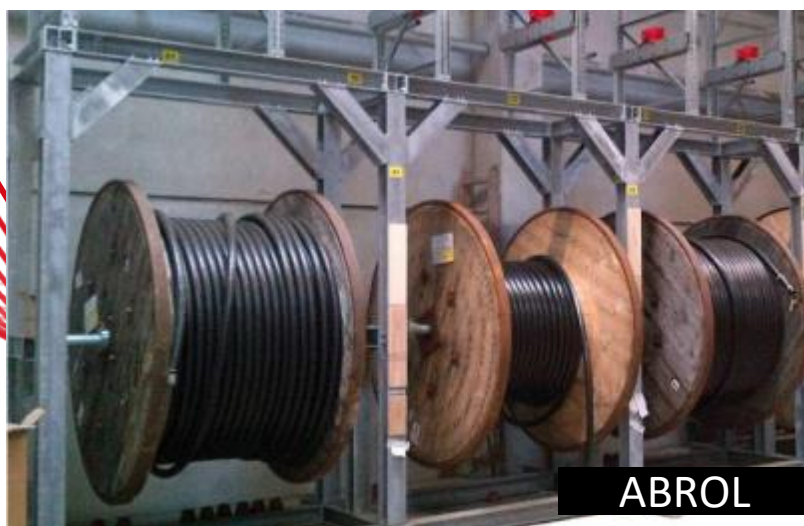

Storage

Transport

Unwinding

Length measurement

Cutting

Winding

Bind & pack



# STORAGE TECHNOLOGY – PULLING OUT OF DRUMS



Storage

Transport

Unwinding

Length measurement

Cutting

Winding

Bind & pack

# ACCESSORIES FOR STORAGE TECHNOLOGY

Cable drum placement tools [Cable drum placement tools – KABELMAT Wickeltechnik](#)



TROMSTOP



TROMPLAT

Length measuring devices [Cable drum placement tools – KABELMAT Wickeltechnik](#)



MESSBOI 10



MESSBOI 25

Storage

Transport

Unwinding

Length measurement

Cutting

Winding

Bind & pack

# COIL, SPOOL AND DRUM UNWINDER

COIL AND SPOOL UNWINDER

[Coil and spool unwinder – KABELMAT Wickeltechnik](#)



RINGO 500



RING-/SPULFIX



KOMBITRAK

DRUM UNWINDER

[Drum unwinder – KABELMAT Wickeltechnik](#)



TROMBOI 500



TROMBOI 800

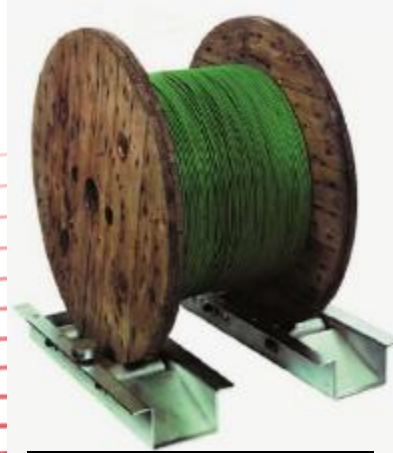

TROMBOI 1400



TROMBOI 7-10/9-14



TROMBOI 2003

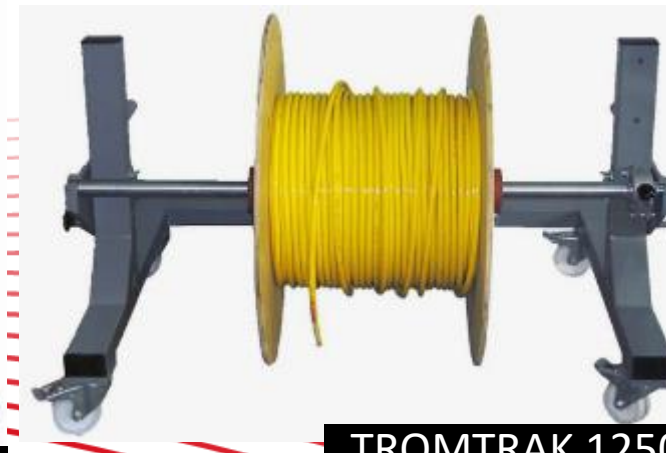

TROMTRAK 1250



TROMCAR 1000/1250

Storage

Transport

Unwinding

Length measurement

Cutting

Winding

Bind & pack

# MANUAL WINDING TECHNOLOGY

Coil and spool winder – KABELMAT Wickteltechnik



TISCHROL 450/1000



MESSROL 450



MESSROL 670/1000

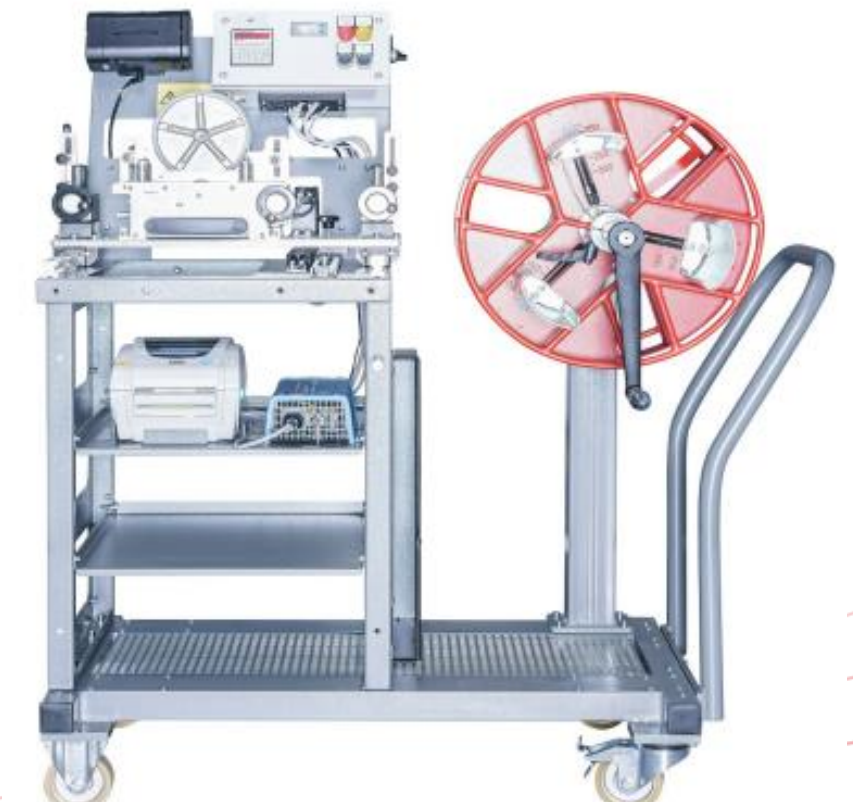

MESSROL 500 – Opt. Akku

Storage

Transport

Unwinding

Length measurement

Cutting

Winding

Bind & pack

# THE ENTRY INTO MACHINE WINDING TECHNOLOGY

[Machine winding technology – KABELMAT Wickteltechnik](#)



MOTROL 500



MOTROL 800 Easy

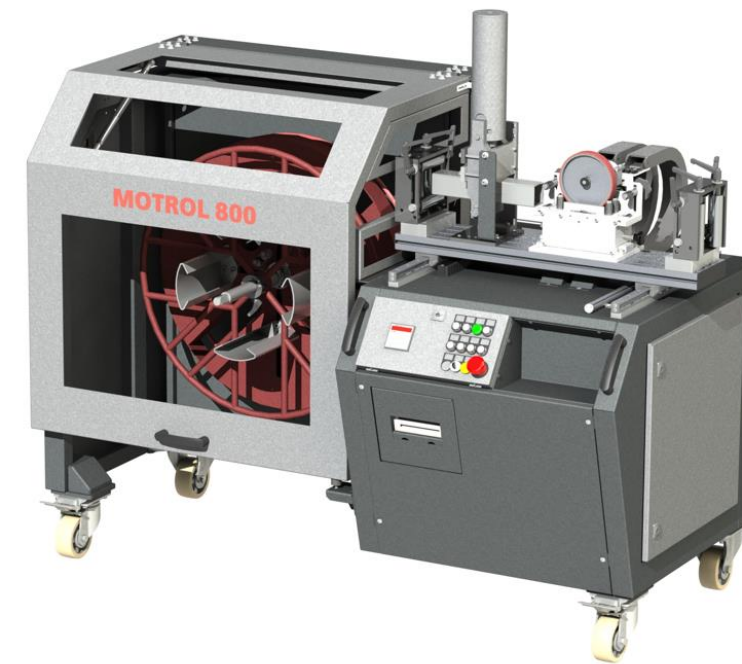

MOTROL 800



MOTROL 1000

Storage

Transport

Unwinding

Length measurement

Cutting

Winding

Bind & pack

# MACHINE WINDING – AUTOCUT 40

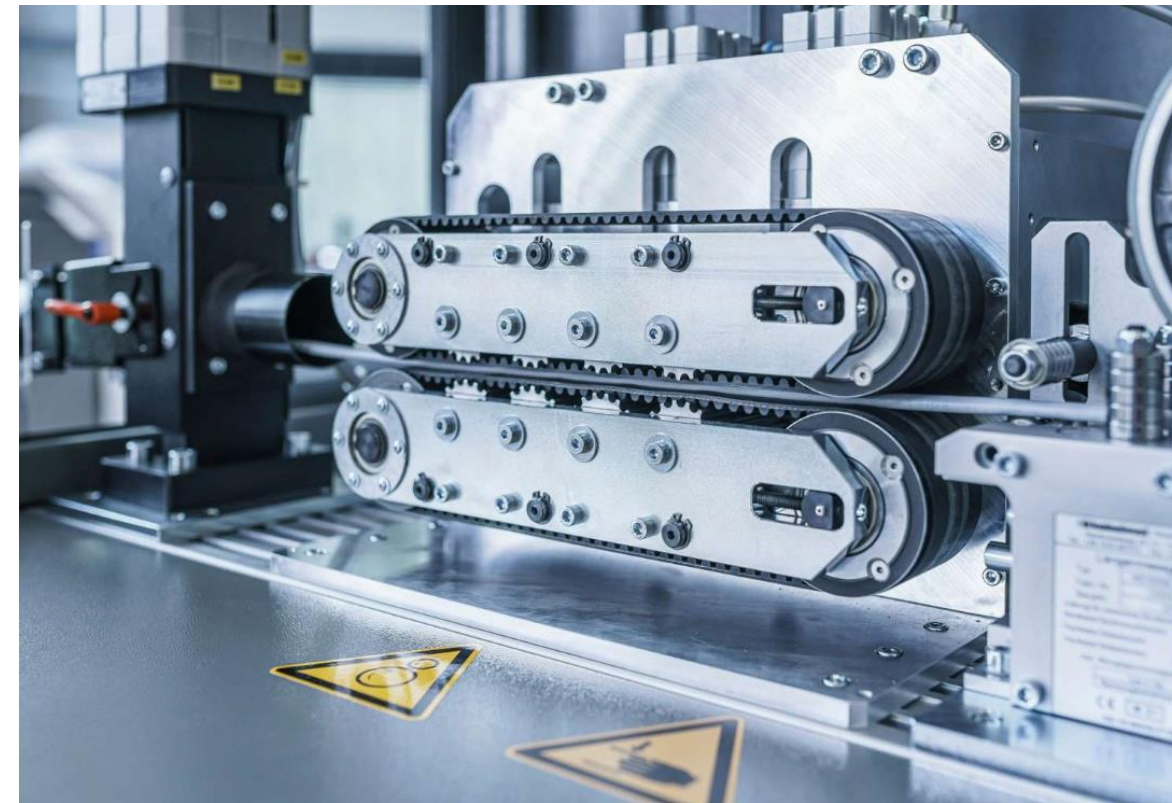

Storage

Transport

Unwinding

Length measurement

Cutting

Winding

Bind & pack

# MACHINE WINDING – RINGROL 600



Storage

Transport

Unwinding

Length measurement

Cutting

Winding

Bind & pack

# MACHINE WINDING – RINGROL AND LAGROL



Storage

Transport

Unwinding

Length measurement

Cutting

Winding

Bind & pack



# MACHINE WINDING – UMROL 1000

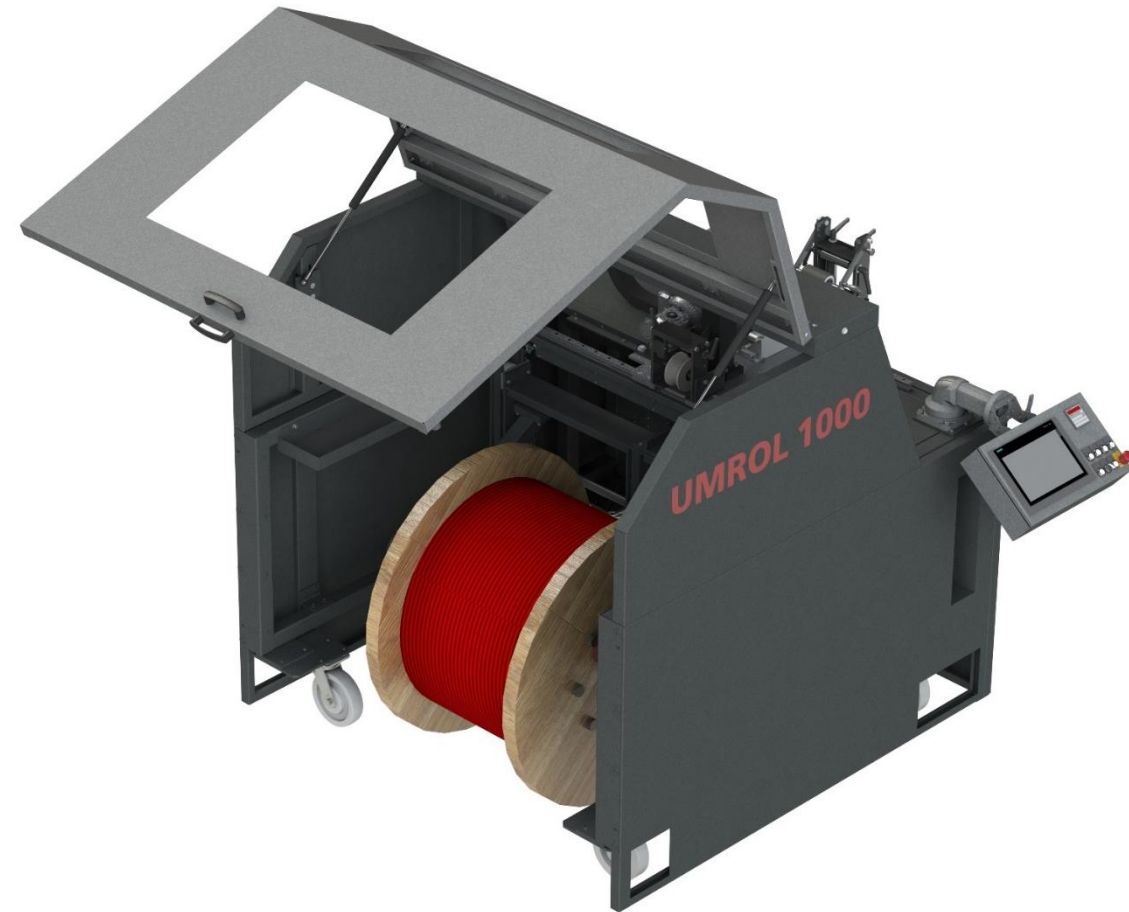

Storage

Transport

Unwinding

Length measurement

Cutting

Winding

Bind & pack

# MACHINE WINDING – UMROL 1400/1600

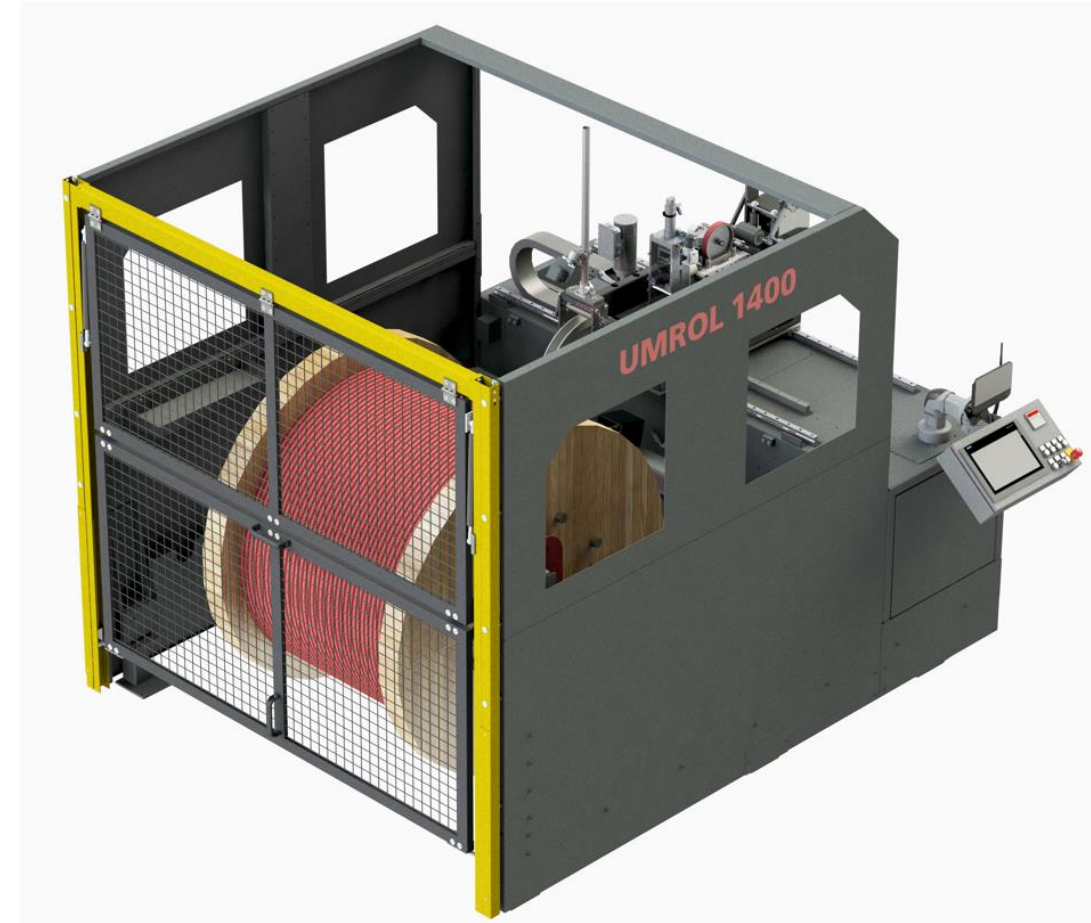

# MACHINE WINDING – UMROL 2200

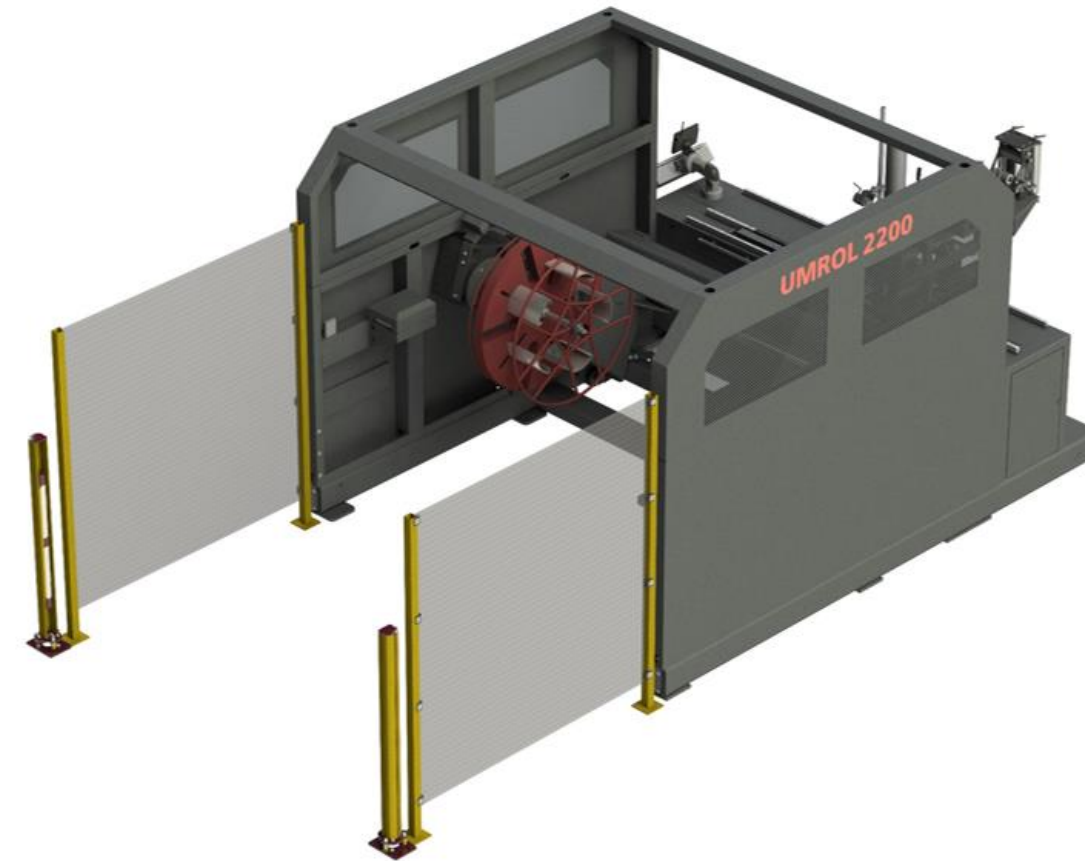
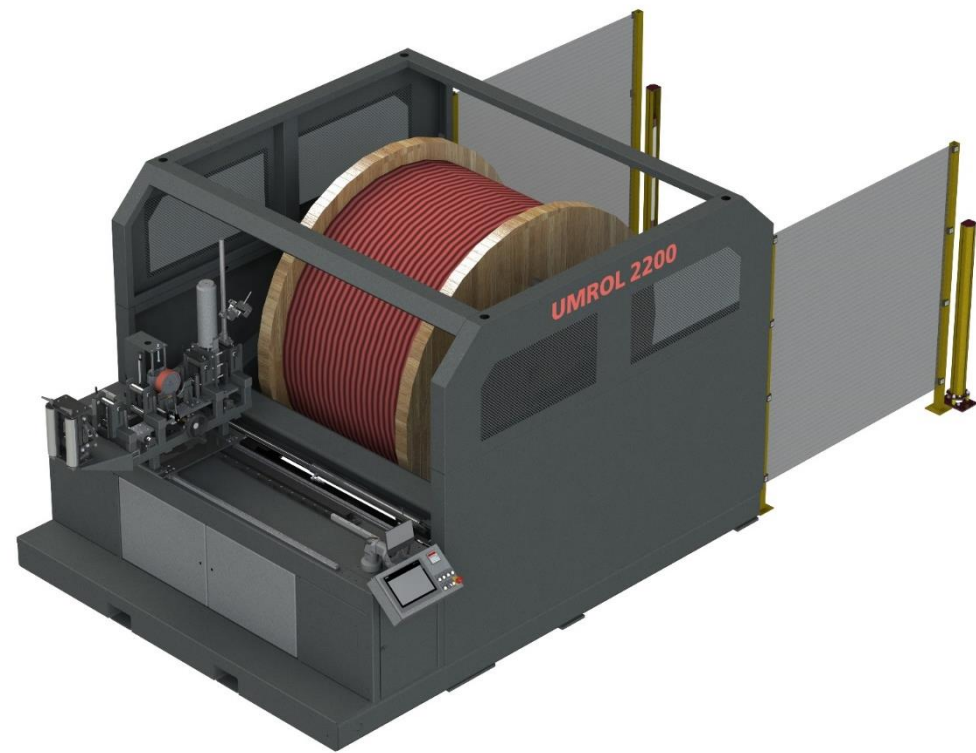

# MACHINE WINDING – Simple Line

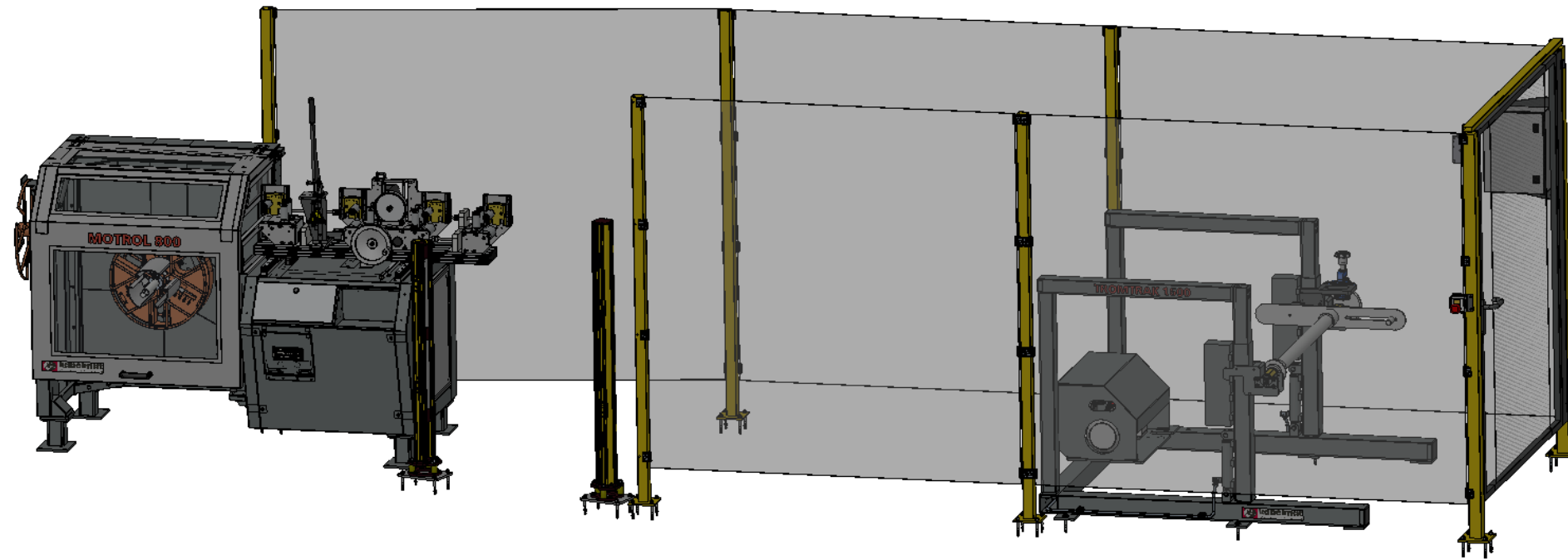

Storage

Transport

Unwinding

Length measurement

Cutting

Winding

Bind & pack

# MACHINE WINDING - Length measuring devices

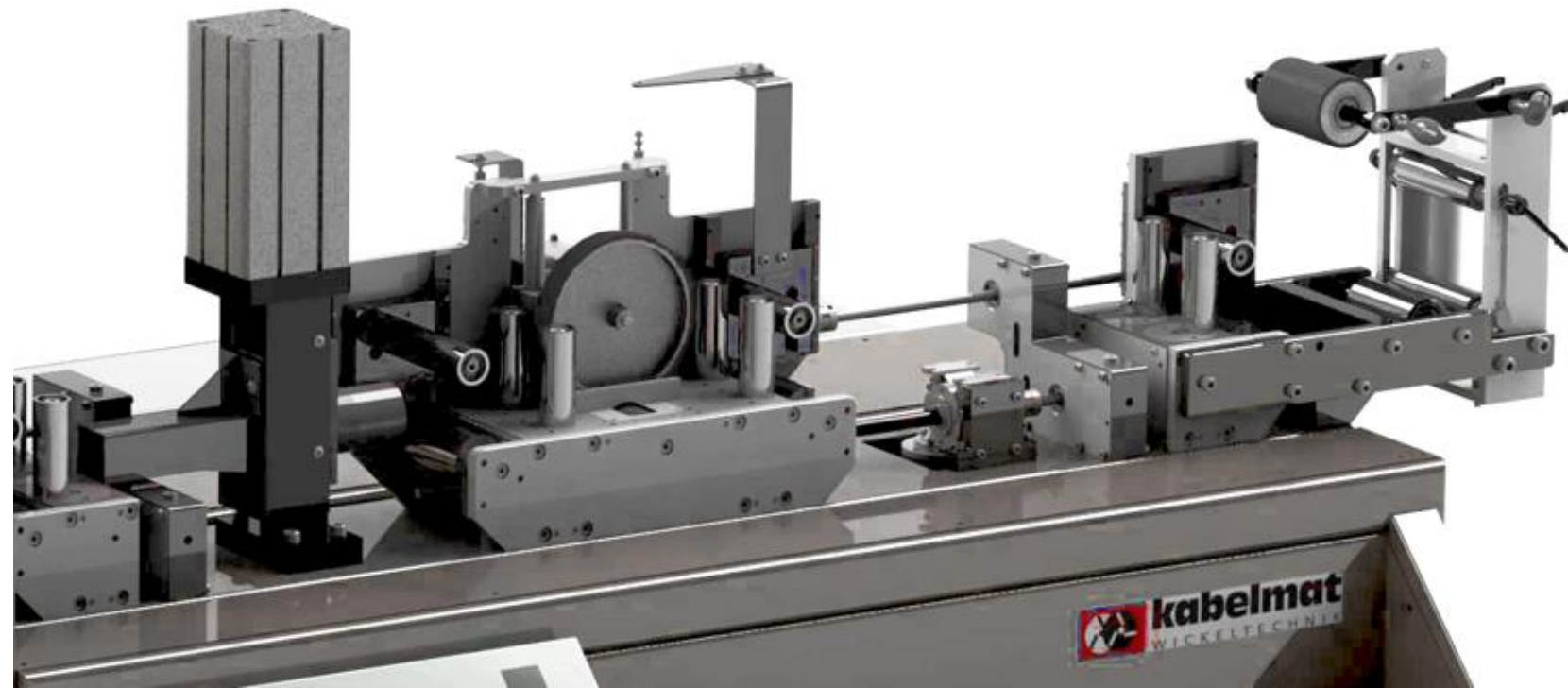

Companies that sell cables to third parties in the course of their business must measure them with length measuring devices that meet the requirements of the European Measuring Instruments Directive. **Kabelmat's length measuring devices have the approval** and are conformity assessed by the regionally responsible calibration authority before delivery to the customers (former initial calibration). All length measuring devices that measure without the presence of the customer, receive a memory for the cutting data and must be calibrated every two years.

Storage

Transport

Unwinding

**Length measurement**

Cutting

Winding

Bind & pack

# MACHINE WINDING – AUTOLOG-Lines

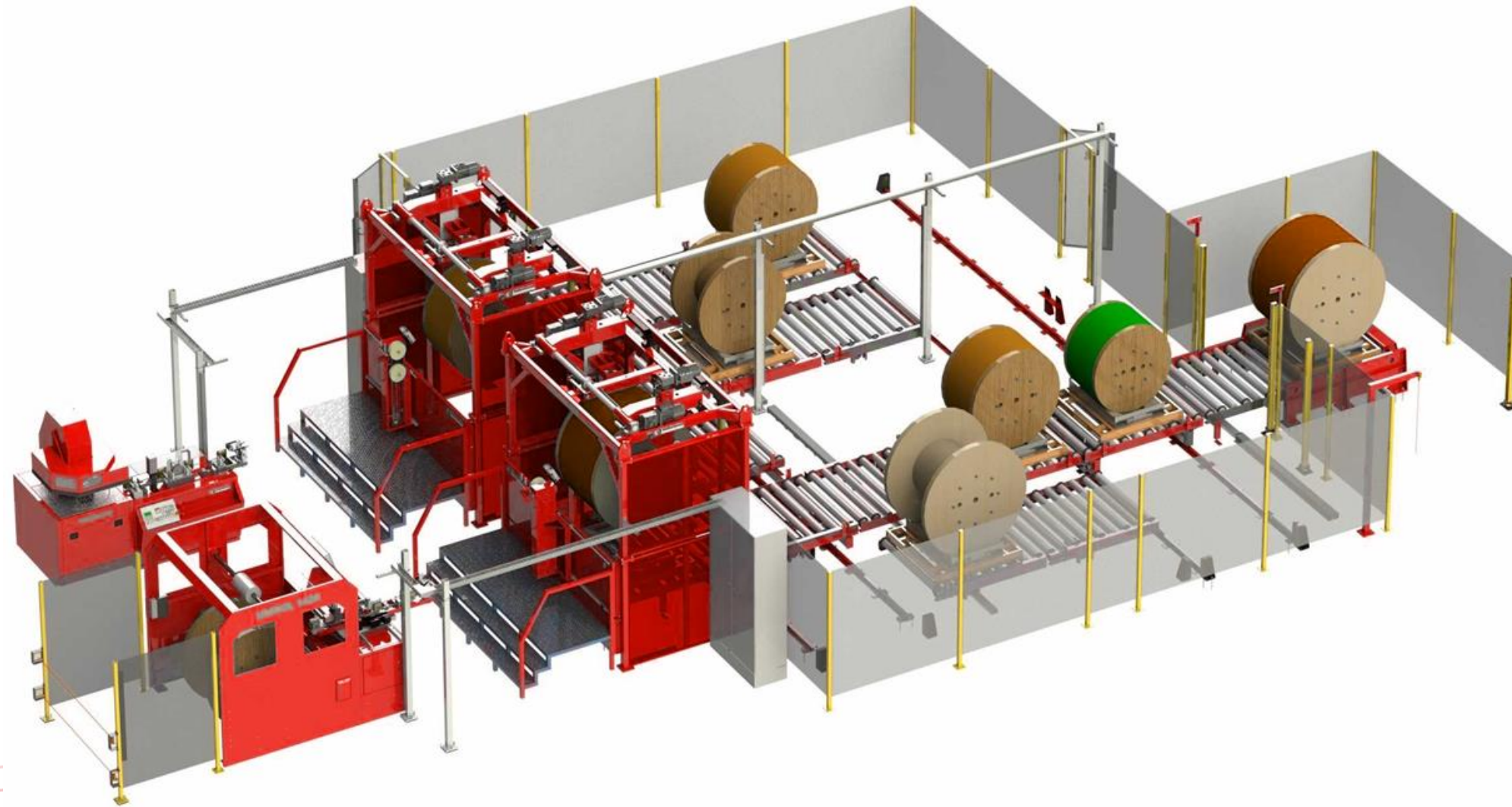

Storage

Transport

Unwinding

Length measurement

Cutting

Winding

Bind & pack

# MACHINE WINDING - Large drum line up to 10t

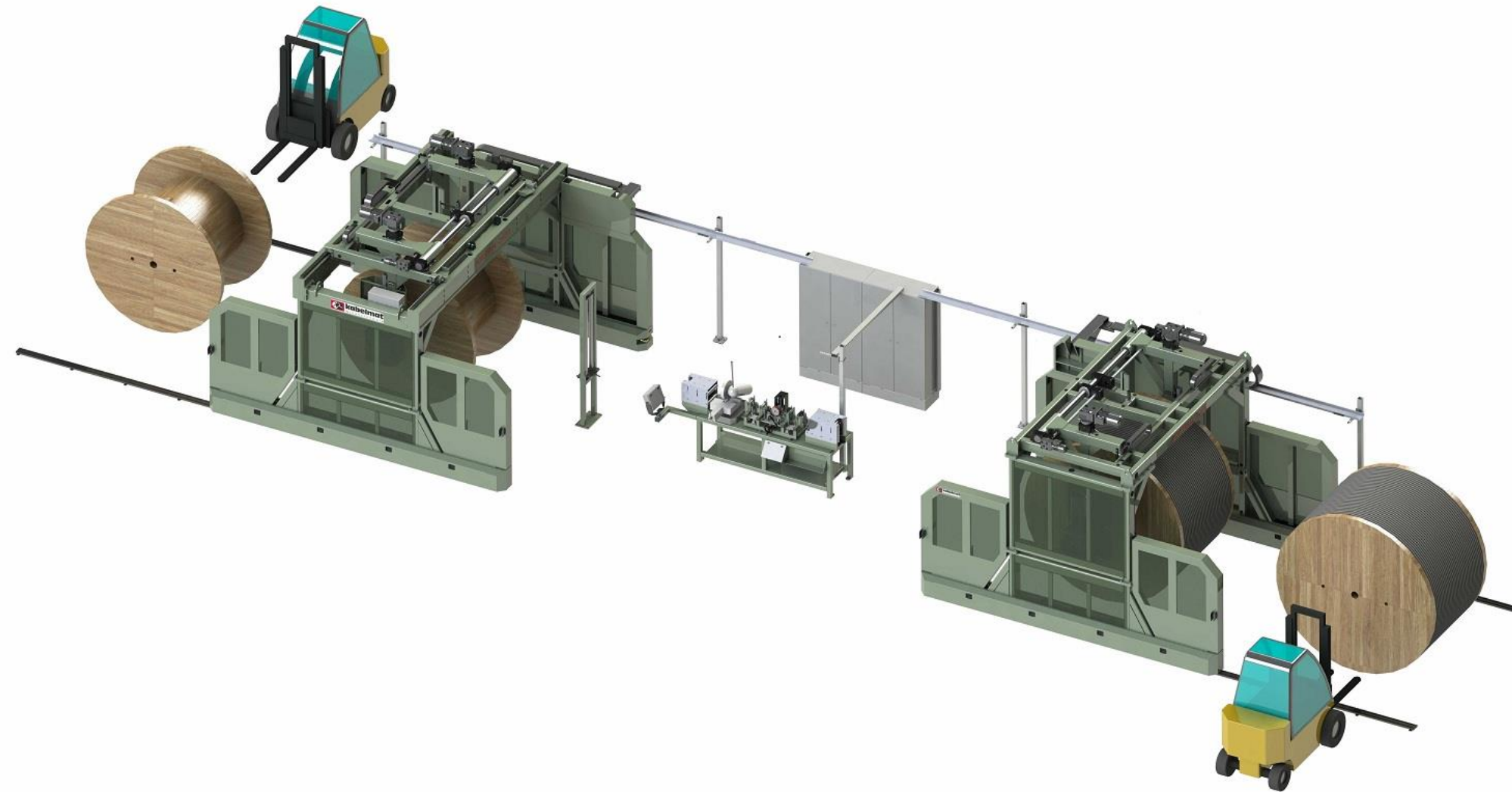

Storage

Transport

Unwinding

Length measurement

Cutting

Winding

Bind & pack

# MACHINE WINDING – RINGROL 300

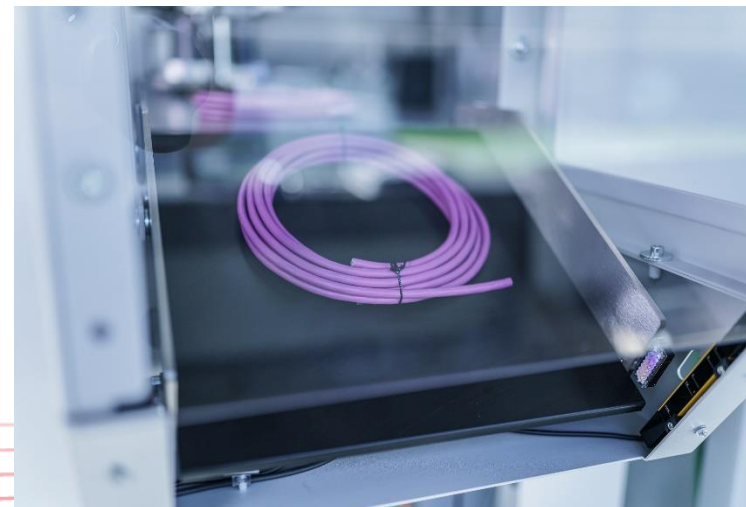

Storage

Transport

Unwinding

Length measurement

Cutting

Winding

Bind & pack



# MACHINE WINDING – RINGROL 400 or 590

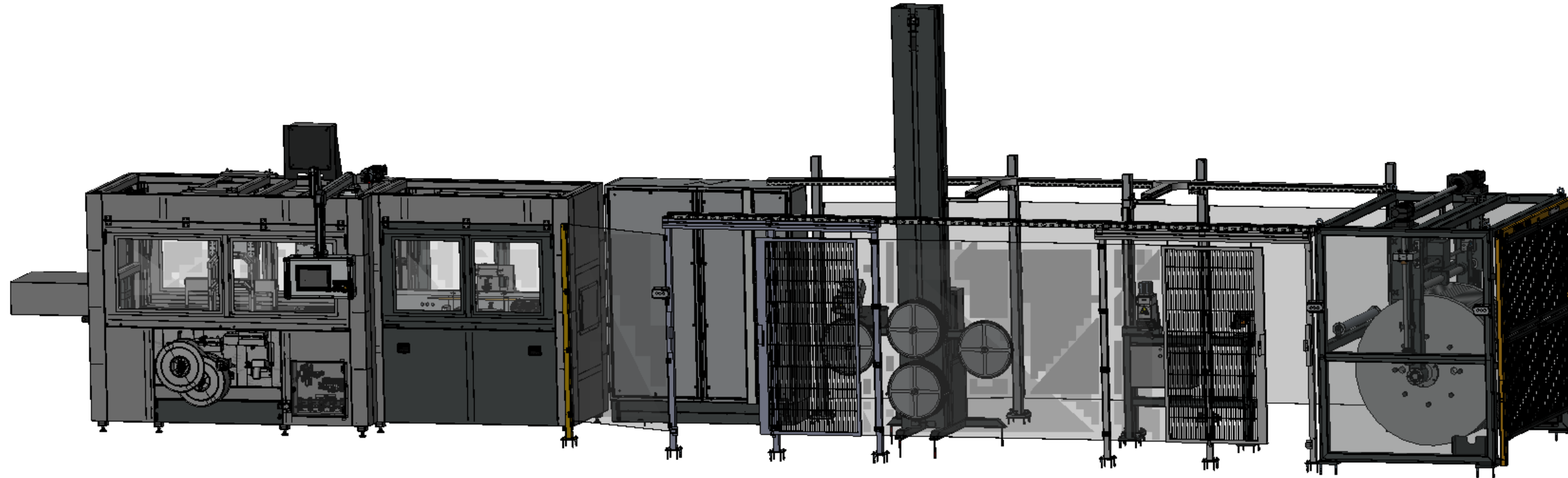

Storage

Transport

Unwinding

Length measurement

Cutting

Winding

Bind & pack

# MACHINE WINDING – RINGROL 1200

RINGROL 1200 in inline operation for e.g. aluminium composite pipes (water pipes)

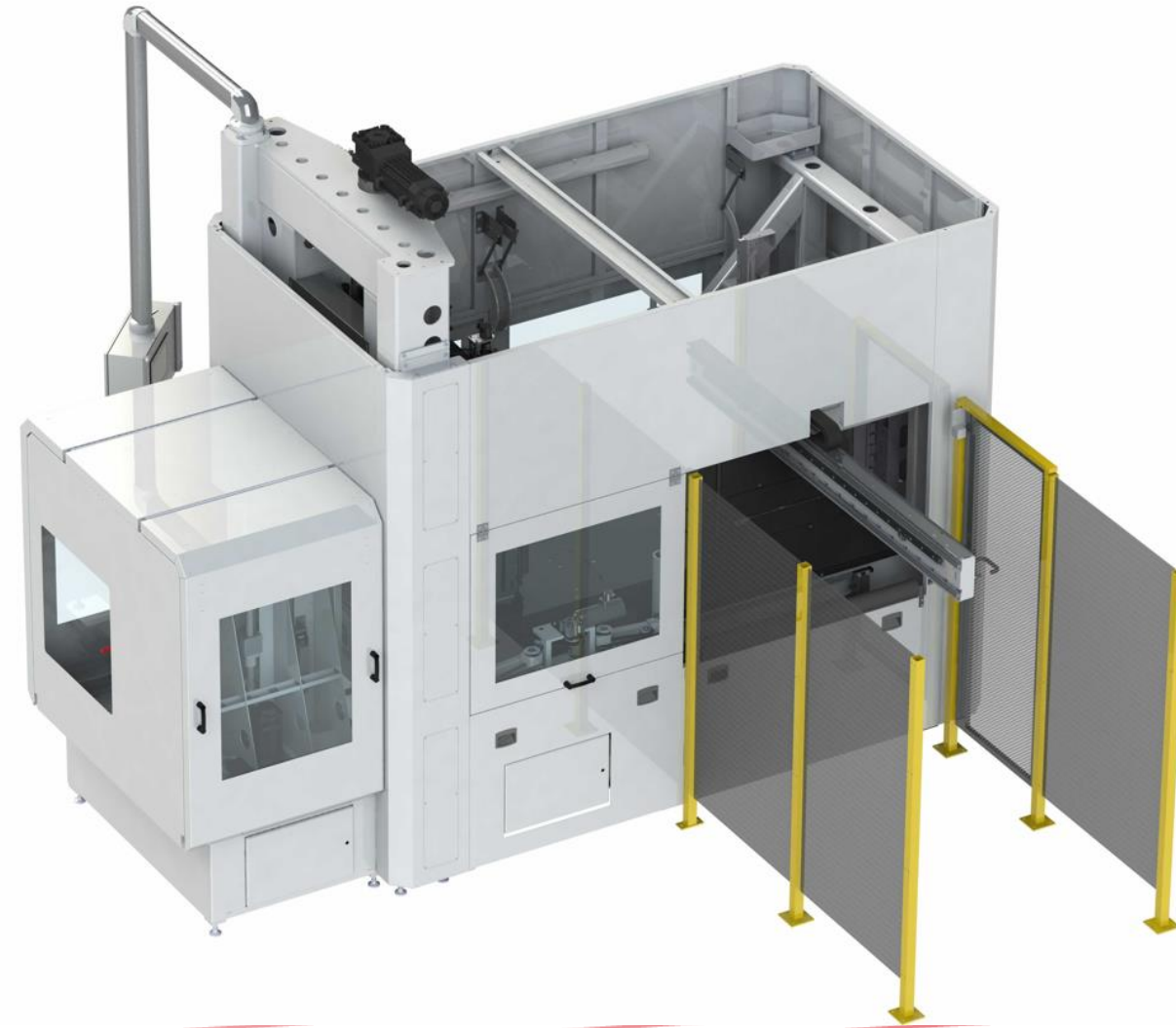

# MACHINE WINDING – SIGNOMAT



Storage

Transport

Unwinding

Length measurement

Cutting

Winding

Bind & pack

# References - Large drum line



# References - Autolog



Kaczmarek  
electric



FISCHER  
ZANDER



sonepar

**FEGA & SCHMITT**  
ELEKTROGROSSHANDEL



Technische Unie



**HELUKABEL**<sup>®</sup>



**REXEL**

**3LP**



**LAPP KABEL**



**kabelmat**<sup>®</sup>

easy winding. easy working.

# References - Electrical wholesale



**HELUKABEL**®



**FAMO**  
Die Kollegen vom Handel



# Contact

## Postal address

Kabelmat Wickeltechnik GmbH  
Steinbuckelweg 25  
72293 Glatten (GER)

---

## E-Mail address

Pascal.schwindhammer@kabelmat.com

---

## Phone number

+49 7443 9670 63 - Landline  
+49 1708 5604 20 - Mobile

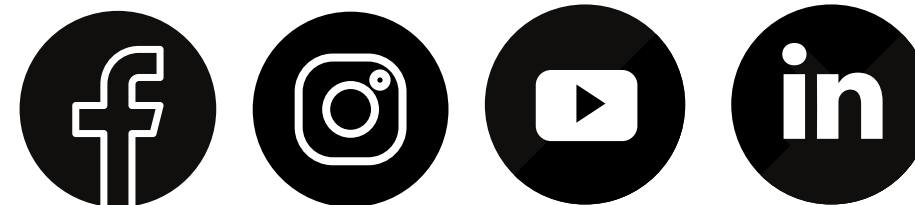



**Thank you for your  
attention.**